

EXPAND YOUR  
LIVING SPACE  
IN STYLE

INNOVATION LIVING™

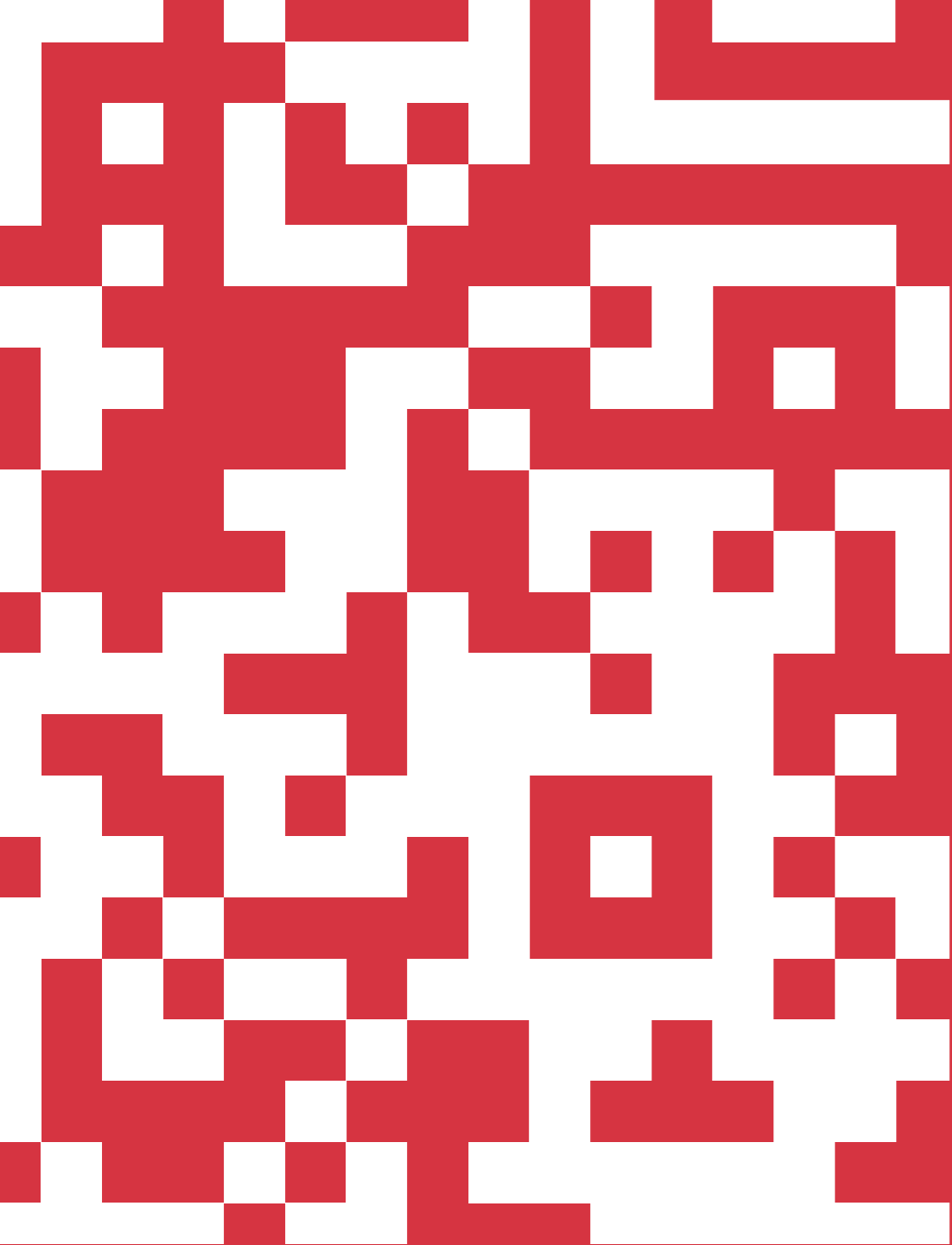

SCAN THE QR CODE  
AT EACH PRODUCT  
PRESENTATION FOR  
MORE DETAILED  
INFORMATION  
ONLINE

## OUR PHILOSOPHY

Innovation Living is a globally recognized sofa bed specialist, renowned for crafting innovative, high-quality, multifunctional furniture that combines aesthetic appeal with practical versatility. Our mission is to create stylish, space-saving solutions that enhance everyday life — whether by maximizing the potential of compact spaces or providing a welcoming and comfortable place for guests to stay overnight.

As consumers, we share a collective responsibility to reassess our consumption habits. Prioritizing durable products designed to stand the test of time is essential, as this is the most effective way to reduce resource consumption and minimize environmental impact.

In line with this philosophy, we are dedicated to delivering designs that excel in aesthetics, functionality, and durability, ensuring long-term usability and value. At the same time, we carefully select materials and construction methods with a focus on sustainability, ease of disassembly, and recirculation potential — further reducing environmental impact.



# SOFA BY DAY BED AT NIGHT

## CONTENT

- 8 **Modular**  
Playfull interaction between sofa and chairs.
- 16 **Compact**  
Limited width as sofa, full size as bed.
- 42 **Unique**  
Designs with an attitude.
- 54 **Daybeds**  
Multifunctional daybeds.
- 74 **Slyders**  
Designs where the seat is slided or lifted out, before flipping down the back for effortless transformation.
- 118 **Multifunctionals**  
Design your personal multifunctional sofa, daybed and bed with head elevation.
- 132 **Accessories**  
Chairs, floor cushions, cushions, tables and beanbags.
- 142 **Collection overview and specifications**  
Full overview of all products including technical information.
- 163 **Fabrics**  
Specifications and collection.

# PRODUCT INDEX

Akello	102
Aslak	122
Balder	124
Bifrost D.E.L.	116
Cassius D.E.L.	114
Colpus	131
Cone	88
Cubed	16
Dublexo	14
Eilis	92
Eivor	35
Fraction	130
Ghia	64
Idun	108
Jillis	42
Junus	128
Killian	34
Long Horn D.E.L.	50
Lomira	126
Luoma	40
Malloy	80
Minimum	120
Neah	24
Newilla	74
Nolis	54
Olan	38
Osvald & Cornila	86
Puri	72
Pyxis D.E.L.	112
Recast	94
Rollo	60
Sigga X	98
Sigmund	56
Sly	96
Splitback	8
Supremax D.E.L.	114
Trym	108
Unfurl	46
Yonata	90
Zeal	62

## WELCOME

Our design philosophy is rooted in a profound respect for individuality, reflecting our belief that people seek to express their unique personalities through the objects they choose to surround themselves with. The 2025 collection exemplifies this vision, featuring a diverse array of designs and styles that celebrate personal expression. This year, we are proud to introduce two new themes, thoughtfully integrated into our collection.

Please enjoy our 2025 collection.

## BOLD & COLORFUL

This part of the collection marks an exciting return to the bold, colorful essence of our heritage, which include a collaboration with the renowned designer Verner Panton. Bold & colorful embrace vibrant, timeless colors in our textile range, introduce reflective surface elements, and showcase a series of eye-catching, colorful tables.



## TIMELESS ELEGANCE

This part of the collection is defined by implementation of trendy 70s-inspired brown and orange tones for enduring sophistication. We strive to offer timeless designs rooted in classical conventions and archetypes, emphasizing the Scandinavian approach to European modernism. The new 70s-inspired fabrics seamlessly complement our existing assortment of timeless fabrics.



Shown in: 512 Elegance, Ultramarine

## SPLITBACK CHROME WITH ARMS

### SLEEK AND MULTIFUNCTIONAL

Splitback Chrome merges modern aesthetics with exceptional functionality. Its sleek chrome legs add a minimalistic touch, giving any room a sophisticated, architectural appeal. Featuring a three-position tilting system, it seamlessly transitions between seating, lounging, and sleeping, making it ideal for entertaining or relaxing. Perfect for urban living, this sofa blends practical elegance with effortless versatility. Splitback Chrome offers a stylish, space-saving solution that combines timeless design with functional ease.

Design by Per Weiss

For product details see page 143 or scan the QR code.



# SPLITBACK FREJ

## TIMELESS SCANDINAVIAN FUNCTIONALITY

Splitback Frej combines Scandinavian craftsmanship with functional design. Its solid oak armrests in the natural lacquered finish or the smoked oak finish add warmth and elegance, while the pocket spring mattress delivers supportive comfort. With independently adjustable backrests offering sofa, lounge, and bed positions, it is perfect for guests or everyday use. Effortlessly convert it into a comfortable bed, ideal for compact spaces. The refined design, clean lines, and natural materials of Splitback Frej bring a harmonious balance of style and practicality to any modern home.

Design by Per Weiss, Oliver & Lukas WeissKrogh  
For product details see page 142 or scan the QR code.





**Did you know:**

Splitback is part of a modular product family, offering customizable leg finishes and armrest options to suit your style.

Pair it with a Splitback Eik or Frej Chair to create a cohesive and stylish seating arrangement, perfect for any space.

For product details see page 142 or scan the QR code.



# DUBLEXO STYLETTO WITH ARMS

## FLEXIBILITY AND STYLE COMBINED

Dublexo Styletto with arms blends sleek design with practical functionality. Its slim oak legs and rounded, modern armrests add sophistication to any space. The three-position tilting backrest combined with the built-in topper offer flexibility and comfort for any occasion, whether used as a sofa, sofa lounger or as a bed. A sturdy metal frame ensures durability while maintaining its lightweight elegance. Flat-packed for easy transport and access, Dublexo is a smart choice for modern living, combining contemporary aesthetics with comfort and versatility.

Design by Per Weiss

For product details see page 144 or scan the QR code.





# CUBED WOOD

## THE SPACE-SAVING SOLUTION WITH STYLE

Cubed Wood is a unique sofa bed designed for compact living. Its solid oak legs bring warmth to the sleek design, making it both functional and stylish - perfect for studios or guest rooms. Featuring an integrated bedding box, it offers convenient storage for essentials while maintaining its elegant simplicity. Delivered flat-packed for easy access, it's ideal for homes with narrow entry.

Enjoy space-saving convenience without compromising on comfort or style with Cubed Wood.

Design by Per Weiss, Oliver & Lukas WeissKrogh

For product details see page 146 or scan the QR code.





## CUBED CHROME

### SLEEK AND SPACE-SAVING DESIGN

Cubed Chrome combines modern elegance with practical functionality. Its polished chrome legs and compact design make it perfect for studio apartments or guest rooms. The No-zag spring and High Resilient foam delivers comfortable support for both sitting and sleeping, while a hidden bedding box provides discreet storage for linens, enhancing space efficiency. Cubed Chrome offers a stylish, versatile solution for contemporary living without sacrificing comfort or design.

Shown in: 528 Mixed Dance, Blue

Design by Per Weiss

For product details see page 146 or scan the QR code.



## CUBED WITH ARMS

### COMPACT SOPHISTICATION

Cubed with arms is a stylish sofa bed designed for modern living. Its streamlined arms and compact design make it ideal for small spaces while maintaining a sleek, elegant aesthetic. The no-zag spring base ensures comfort for both sleeping and seating, while the angled seat adds extra comfort when used as a sofa. Effortlessly transforming from sofa to bed, it's perfect for hosting guests. Cubed with arms offers a smart, space-saving solution that combines functionality and style for contemporary interiors.

Shown in: 565 Twist, Granite

Design by Per Weiss

For product details see page 146 or scan the QR code.



# CUBED ALU

## ELEGANT SPACE-SAVING DESIGN

The Cubed chair blends innovative functionality with sleek design, making it perfect for modern, multifunctional spaces. Its aluminum legs contrast beautifully with vibrant red upholstery, creating a striking visual appeal. Effortlessly transforming into a single bed, it is ideal for urban living. A hidden bedding box offers practical storage, while the no-zag spring system ensures optimal comfort. Compact yet versatile, the Cubed chair is a smart solution for maximizing space without compromising on style or comfort.

Design by Per Weiss, Oliver & Lukas WeissKrogh  
For product details see page 146 or scan the QR code.



Shown in: 511 Elegance, Red

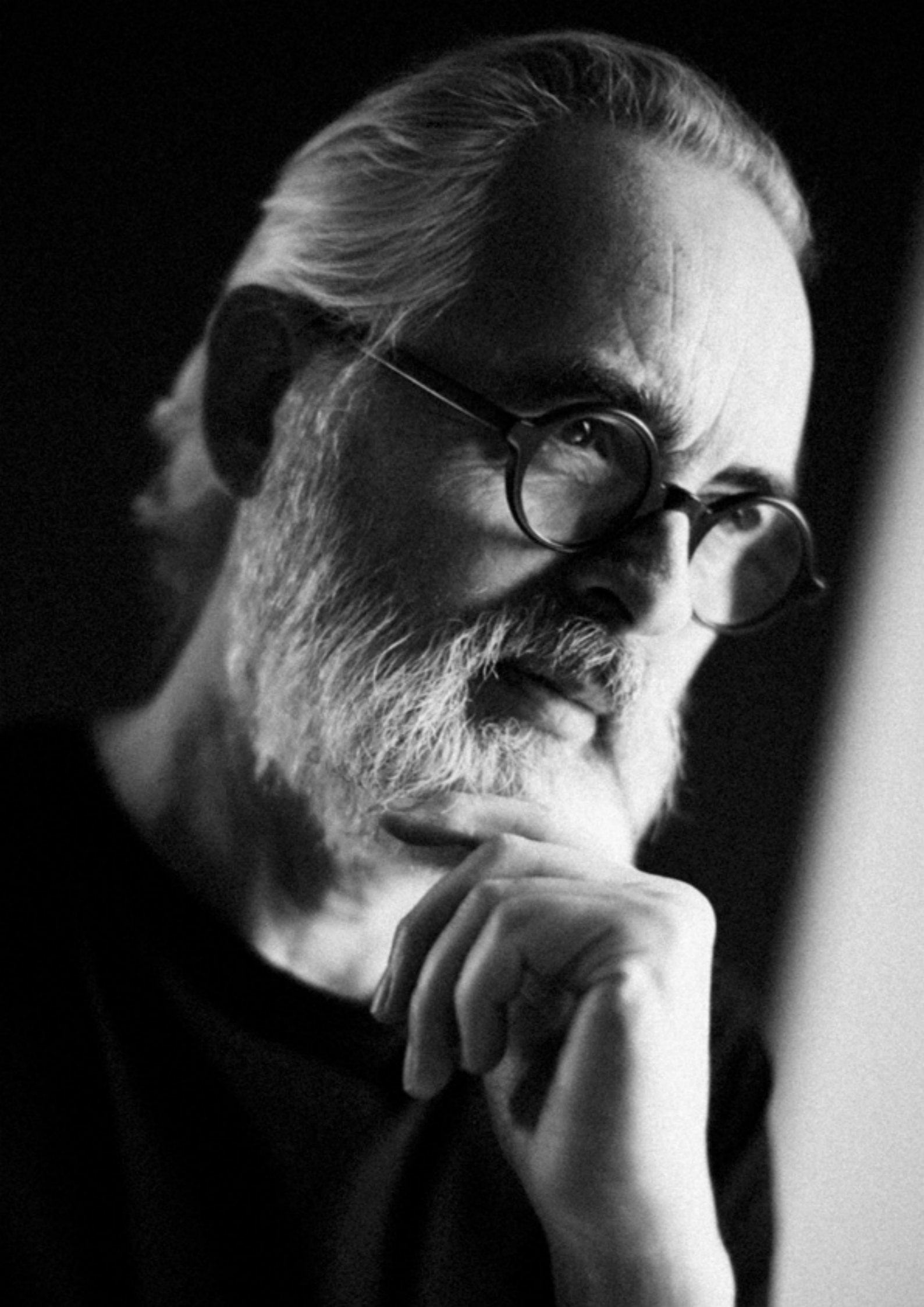

## PER WEISS CHIEF DESIGN OFFICER

Per Weiss, born in Denmark in 1959, is a distinguished Danish designer and currently serves as the Chief Design Officer at Innovation Living. A pivotal member of the company since 1989, he has been the creative driving force behind the consistent evolution and development of its collections.

Weiss's career began in the arts, where he pursued his passion as a professional rock musician. However, his creative aspirations ultimately led him to design. In 1988, he graduated as an industrial designer from the School of Architecture in Aarhus. Following his graduation, Weiss honed his design skills working briefly with renowned Danish architectural firms such as Schmidt, Hammer & Lassen, and Friis & Moltke, before committing fully to his design vision.

Innovation Living initiated a groundbreaking collaboration in 1996 with the iconic designer Verner Panton. Together, they worked on pioneering projects such as the Phantom Chair, Panto Pop, Panto Beam, and Illumesa. This partnership fostered a close and inspiring dialogue between Panton and Weiss, which continued until Panton's passing in 1998.

Weiss's design philosophy is deeply rooted in a respect for the modernist European design tradition, with a natural affinity for the Scandinavian design ethos. His work embodies a commitment to creating innovative, functional, and enduring designs that enhance everyday life and deliver both aesthetic and practical value.

Through his leadership and vision, Weiss remains dedicated to the pursuit of timeless and transformative design, ensuring a lasting impact on the world of contemporary interiors.

# NEAH X

## BOLD DESIGN MEETS PRACTICAL FUNCTIONALITY

Neah X combines striking design with everyday practicality. Its vibrant blue fabric, accented by striking orange zigzag stitching, makes a bold statement in any contemporary interior. Featuring spacious seating and supportive cushions, it ensures superior comfort for lounging or sleeping. Seamlessly transitioning into a bed, Neah X adapts effortlessly to your needs. With a sturdy frame and vibrant aesthetic, Neah X offers a perfect blend of standout style and functional versatility in one distinctive sofa.

Design by Per Weiss

For product details see page 147 or scan the QR code.



Shown in: 512 Elegance, Ultramarine |  
Geobau table see page 134



# NEAH FAMILY

## UNMATCHED, INNOVATIVE COMFORT - TIMELESS APPEAL

Neah combines sleek aesthetics with a unique comfort construction. We have reimagined the traditional sofa bed comfort by combining our solid metal frame with a no-zag suspension system and a pocket spring core encased in a plush high resilient foam layer. With a simple pull, Neah transforms into a spacious lounge or bed, providing friends and family with a comfortable place to watch a movie or sleep. Balancing style and functionality, Neah is the perfect choice for modern homes, offering the highest comfort - both as sofa, lounge and bed.

Design by Per Weiss

For product details see page 147 or scan the QR codes.



Neah  
Slim Arm



Neah  
Standard Arm





*"A sofa bed often mean compromising on looks, Neah's best feature is that it looks and feels like a regular sofa"*

Shown in: 357 Taura, Off White

# Compact Living

Meet Mikkel (39), Nino (33) and their daughter Mira, Living in Aarhus, Denmark  
Squaremeters: 48m<sup>2</sup>

## **Small Space, with a rich Life:**

### **Mikkel and Nino's Creative Aarhus Home**

In the heart of Aarhus, where charming cobblestone streets meet a vibrant cultural scene, Mikkel and Nino have created a home that perfectly balances creativity, practicality, and a love for life's small pleasures. The couple, along with their baby daughter Mira, has embraced the art of small-space living in their cozy city-center apartment.

## **The life of Aarhus**

When asked why they have chosen Aarhus, Mikkel replies. "I love the big-slash-small size of the city," he says, describing the appeal of its intimate streets, lively cultural scene, and a wide selection of bars and restaurants just around the corner. For Nino, born and raised in Georgia, Aarhus has a lot to offer: "It's a very welcoming city," "It was so easy to integrate as a foreigner." She replies.

## **Prioritizing location over space**

Living in the heart of Aarhus comes with its challenges, especially in terms of space. But for Mikkel and Nino, the compromises are worth it. Mikkel, who's accustomed to compact living, finds their small apartment cozy. "For me, moving here wasn't hard," he says. "We prioritized living in the city center, and that meant compromising on space."

Nino nods in agreement, highlighting how their lifestyle choices align with their living situation. "We prioritize experiences over things," she explains. This philosophy allows them to travel frequently, particularly to Georgia to visit Nino's family. "It's important for us to meet often and for them to spend quality time with their granddaughter."



Nino and Mira enjoying the family lounger position and comfort of Neah.

#### **Making space work**

One essential addition to their home was a sofa bed—a choice that came with some initial hesitation from Mikkel. “For me, sofa beds often mean compromising on looks,” he admits. But Nino insisted, knowing the practicality it would bring to their apartment.

“It was crucial for accommodating visiting family,” she says, adding that this particular sofa bed met both her practical needs and Mikkel’s aesthetic standards.

The sofa has become a centerpiece of their social life. From hosting Nino’s mother for extended stays to welcoming friends from around the globe, their home has become a hub of connection. “I used to travel a lot and therefore I’ve connected with people from everywhere whom are now my friends.” Mikkel shares. “It’s nice to offer them a place to stay, and the sofa bed makes it easy to couch surf.”

#### **Creativity and culture at their doorstep**

Both Mikkel and Nino are creative souls, and Aarhus fuels their passions. Mikkel’s guitar hangs proudly on the wall, a testament to his musical interests, while Nino’s love for photography often leads her to local exhibitions. Their neighborhood, with its jazz bars and cozy streets, serves as an endless source of inspiration.

“We love how everything is right outside our doorstep,” Nino says. “From concerts to restaurants, Aarhus offers a perfect blend of culture and community.”

#### **Embracing small-space living**

Despite the compromises, Mikkel and Nino have found joy in their compact living situation. “It’s all about balance,” Mikkel explains, reflecting on his freelancing career and the unpredictability it brings. For now, their small, thoughtfully arranged home allows them to enjoy life in one of Denmark’s most charming cities without overstretching their resources.

With Mira giggling in the background and sunlight streaming through their apartment windows, it’s clear that this family has mastered the art of making the most of what they have. Aarhus isn’t just where they live—it’s where they thrive.

Scan the QR code to see the video about Mikkel and Nino





**TIMELESS DESIGN WITH UNMATCHED ADAPTABILITY**

The Neah chair combines classic elegance with versatile functionality. Its semi-automated mechanism allows a seamless transition between a chair, a relaxing chaise lounge, and a single bed. Crafted with a durable metal frame no-zag and pocket springs, it ensures long-lasting comfort. Optional slim or standard arms let you personalize its design to suit your style. Perfect for compact living, the Neah offers a stylish and flexible solution for relaxing, lounging, or hosting overnight guests.

**Design by Per Weiss**

For product details see page 147 or scan the QR code.



**NEAH FAMILY**



Neah Slim Arm | Bed size 80x195 cm



Neah Slim Arm | Bed size 140x195 cm



Neah Slim Arm | Bed size 160x195 cm



Neah Standard Arm | Bed size 80x195 cm



Neah Standard Arm | Bed size 140x195 cm



Neah Standard Arm | Bed size 160x195 cm

Shown in: 357 Taura, Off White

**Design by Per Weiss**

For product details see page 147 or scan the QR codes.



Neah Slim Arm



Neah Standard Arm

# KILLIAN

## CONTEMPORARY COMFORT AND PRACTICALITY

Killian is a modern sofa bed with a sleek, minimalist design. Wide, rounded arms and a streamlined silhouette enhance its appeal in contemporary spaces, while the separate mattress ensure exceptional support for lounging or sleeping. Killian is available in two sizes and with different mattress comforts. With a high quality built-in bed platform, it transitions effortlessly into a spacious bed, ideal for hosting guests. Killian combines timeless style and functionality in a compact, versatile solution for modern living.

Shown in: 539 Bouclé, Beige

Design by Per Weiss

For product details see page 148 or scan the QR code.

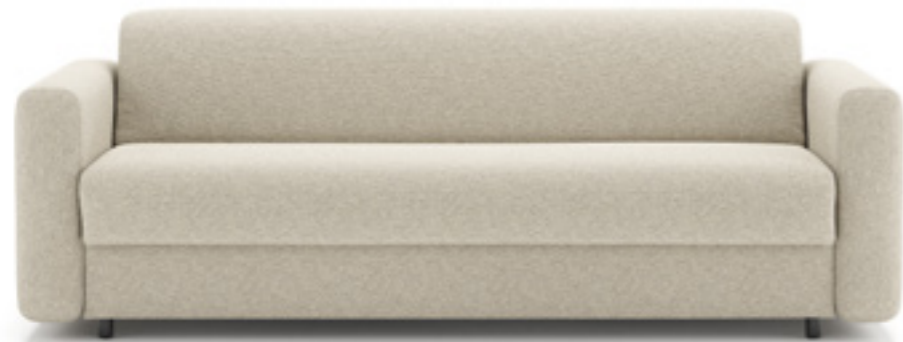
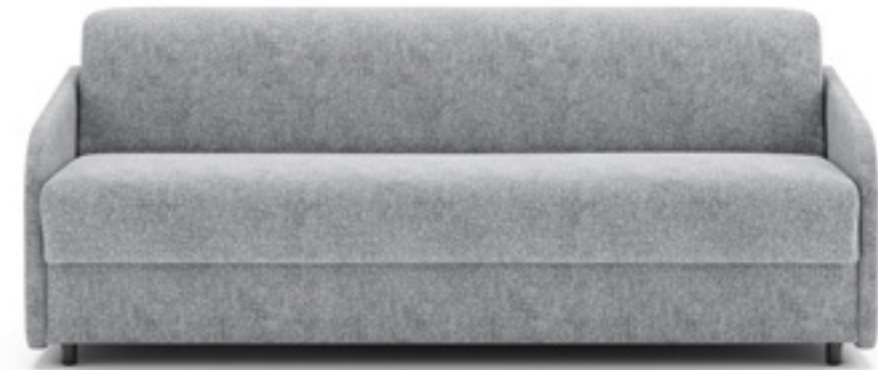

# EIVOR

## COMPACT DESIGN WITH EFFORTLESS ELEGANCE

Eivor delivers sophisticated functionality for compact spaces. Its tailored silhouette, sleek upholstery, and slim armrests create a cozy yet refined look. Eivor is available in two sizes and with two different mattress comforts. Designed for compact, modern homes, Eivor effortlessly transforms into a comfortable bed with its innovative high quality built-in bed platform. Perfect for hosting guests. Balancing comfort and style, Eivor offers a practical yet elegant solution for multifunctional interiors, making it an ideal sofa bed choice.

Shown in: 565 Twist, Granite

Design by Per Weiss

For product details see page 148 or scan the QR code.





## EXPERIENCE UNMATCHED SOFA BED COMFORT

At Innovation Living, we are dedicated to delivering exceptional comfort and lasting quality in every sofa bed we create. As seasoned specialists in sofa bed design, we draw on our expertise to select and apply the best materials and techniques, ensuring premium comfort across all functionalities.

When used as a sofa, our designs provide targeted support at key pressure points, ensuring optimal seating comfort. When transformed into a bed, they are crafted to support the distributed body weight, promoting restful and rejuvenating sleep. Achieving the perfect balance between these dual functions is a complex challenge - one we meet with unwavering dedication to ensure an unparalleled sofa bed comfort.

# OLAN

## COMPACT, CONTEMPORARY COMFORT

Olan is a space-saving sofa bed that combines Scandinavian simplicity with versatile functionality. Its slim arms, compact frame, and lacquered oak legs create a sleek, minimalist aesthetic. Featuring automatic folding legs, Olan transitions effortlessly from sofa to bed, supported by a durable no-zag spring system for lasting comfort. Ideal for small apartments or multifunctional rooms, it blends practicality with elegance.

Design by Per Weiss

For product details see page 147 or scan the QR code.



Shown in: 565 Twist, Granite | Tin Drum table see page 134

# LUOMA

## STYLISH VERSATILITY IN A COMPACT SOFA

Luoma combines timeless design with everyday convenience in a versatile, space-saving sofa. Its refined silhouette, slender arms, black signature piping, and tailored cushions enhance any modern interior. Resting on slim black metal legs, Luoma's sturdy base perfectly balances style and functionality. With a smooth pull-out mechanism, it effortlessly transforms into a spacious double bed. Designed for modern spaces, Luoma offers a practical yet chic solution, blending comfort, elegance, and convenience in one compact piece.

Design by Per Weiss

For product details see page 148 or scan the QR code.





## JILLIS

### TIMELESS ELEGANCE WITH MODERN VERSATILITY

Inspired by mid-century modernism, Jillis redefines multifunctional furniture by obtaining a slim, stylish look, yet still offering a very comfortable sit and sleep through the innovative combination of metal frames, no-zag spring and high resilient foam. Its slim, elegant chrome legs and channel-stitched upholstery exude refined sophistication. Jillis transitions effortlessly from sofa to bed, making it perfect for relaxation or hosting guests. A harmonious blend of timeless design and modern versatility, Jillis serves as a sophisticated centerpiece for any room.

**Design by Per Weiss**

For product details see page 149 or scan the QR code.



Shown in: 511 Elegance, Red | Geobau table see page 134

# JILLIS WITH ARMS

## TIMELESS, ELEGANT MULTIFUNCTIONAL SOFA

Jillis with arms reimagines multifunctional furniture with mid-century modern elegance. Featuring slim, chrome legs, upholstered arms, and channel-stitched detailing, it blends sophistication with practicality. Its high back and plush seating provide exceptional comfort, while the clever design transitions effortlessly into a bed, ideal for relaxation or hosting guests. With luxurious upholstery and refined details, Jillis with arms offers a perfect harmony of style, comfort, and functionality for any modern interior.

Design by Per Weiss

For product details see page 149 or scan the QR code.



Shown in: 280 Avella, Sand

# UNFURL TEDDY

## COZY COMFORT IN TIMELESS DESIGN

Unfurl Teddy blends plush comfort with elegant design. Its soft fabric creates a warm, inviting feel, while dark oak legs add modern sophistication. Compact yet multifunctional, this sofa bed is perfect for urban living or versatile spaces. Designed with high-quality materials, it ensures durability and lasting charm. Unfurl Teddy is more than a stylish centerpiece - it is a practical solution that elevates the ambiance of any modern interior with comfort and timeless appeal.

Design by Andreas Lund,  
Flemming Højfeldt & Per Weiss  
For product details see page 148  
or scan the QR code





# UNFURL

## A FUSION OF STYLE AND MULTIFUNCTIONALITY

Unfurl captures timeless elegance with its clean lines and minimalist profile, complemented by dark lacquered oak legs for a sleek, modern aesthetic. The multifunctional mechanism allows effortless adjustment between three positions - sitting, reclining, or sleeping - offering versatility for any need.

Built for durability, Unfurl combines long-lasting comfort with practical functionality. Its seamless transition from sofa to bed makes it perfect for both daily living and hosting guests.

Enhance your space with Unfurl, a stylish and multifunctional solution for modern living.

Design by **Andreas Lund, Flemming Højfeldt & Per Weiss**  
For product details see page 148 or scan the QR code.



Shown in: 594 Corduroy, Ivory



Shown in: 411 Esina, Cedar Brown

# UNFURL LOUNGER

## TIMELESS DESIGN FOR A FLEXIBLE LIFESTYLE

The Unfurl Lounger combines clean lines with timeless elegance, bringing Scandinavian simplicity to your home. Supported by slim wooden legs, its minimalist design complements any space.

Engineered for versatility, this sofa bed transitions effortlessly from a sofa to a double bed, perfect for compact spaces or multifunctional rooms. It offers both comfort and convenience for you and your guests.

Design by **Andreas Lund, Flemming Højfeldt & Per Weiss**  
For product details see page 149 or scan the QR code.



# LONG HORN

## MODULAR ELEGANCE FOR MODERN LIVING

The Long Horn merges characteristic design with exceptional flexibility. This modular sofa and chair set adapts effortlessly to your needs, serving as a stylish lounge or standalone pieces for versatile layouts. Integrated wheels make repositioning a breeze, while plush upholstery and matching pillows provide superior comfort. Smoothly transitioning between sofa, lounge, and bed modes, Long Horn is perfect for compact spaces. With its contemporary aesthetic and adaptable functionality, Long Horn is the ultimate solution for modern, flexible living.

Design by Per Weiss, Oliver & Lukas WeissKrogh  
 For product details see page 149 or scan the QR codes.



Without arms



With arms





## OLIVER & LUKAS WEISSKROGH

Brothers Oliver and Lukas run Studio WeissKrog, a design studio specializing in furniture and product design. Based in Aarhus, Denmark, the studio reflects their passion for thoughtful, timeless design. Both brothers graduated from the Design School Kolding with degrees in industrial design, providing a strong foundation in craftsmanship and innovation.

Rooted in their Scandinavian heritage, their design philosophy blends simplicity, functionality, and aesthetic clarity. Their upbringing fostered a deep appreciation for design, architecture, and art, shaping a timeless yet contemporary design language.

Thoughts about environmental responsibility are central to their design process, guiding material choices and production methods to help reduce environmental impact while ensuring quality and longevity. Their goal is to craft timeless designs that remain relevant and appealing for generations to come.

# NOLIS

## A SCANDINAVIAN AWARD WINNING DESIGN

Nolis combines sleek Scandinavian design with practical functionality. Its solid oak frame highlights natural craftsmanship, while textured upholstery adds warmth and sophistication. In recent years Nolis has been awarded several awards for its outstanding design. With a reclining seat that transitions effortlessly from a stylish sofa to a spacious daybed, Nolis is perfect for hosting guests or relaxing. Compact and versatile, it fits seamlessly into urban living spaces. Timeless in design and exceptionally comfortable, Nolis embodies the essence of Scandinavian style and modern versatility.

Design by Oliver & Lukas WeissKrogh

For product details see page 151 or scan the QR code.



Shown in: 539 Bouclé, Beige

# SIGMUND DRIP

## DESIGNED FOR MODERN, FLEXIBLE LIVING

Sigmund Drip combines flexibility and style in a compact daybed. Featuring two separate mattresses it adapts to various needs - sofa, single or double bed. The solid oak legs add a subtle elevation, creating a balanced, modern look that complements any decor.

Paired with two plush cushions accented by stylish buttons, Sigmund Drip offers both comfort and visual appeal. Sigmund Drip is ideal for those seeking a versatile, space-saving solution without sacrificing style - perfect for modern, dynamic living spaces.

Design by Per Weiss  
 For product details see page 151 or scan the QR code.



Shown in: 411 Esina, Cedar Brown

# SIGMUND INDU

## DESIGN, COMFORT & PRACTICAL PLAYGROUND

Sigmund Indu combines modern aesthetics with versatile functionality. Its soft cushions and refined black metal legs create a minimalist profile that enhances contemporary interiors. Designed for adaptability, it transitions seamlessly between a sofa, daybed, two single beds, or a double bed configuration. The latter is often used as a practical playground, elevating intimate moments slightly off the floor. Both mattresses feature pocket spring comfort—exactly as found in traditional box spring mattresses. Perfect for compact spaces, Sigmund Indu delivers both practicality and style, making it an ideal choice for modern homes seeking adaptable and chic furniture solutions.

Design by Per Weiss

For product details see page 151 or scan the QR code.





## ROLLO STYLETTO

### A DAYBED WITH ENDLESS POSSIBILITIES

Rollo is the ultimate blend of elegance and practicality, crafted with small-space living in mind. Both sides of the daybed feature a 5-step elevation mechanism, allowing you to customize the angle for sitting, lounging, or sleeping. A built-in magazine pocket enhances functionality, keeping essentials within reach. Available with various leg and mattress options, Rollo allows you to tailor its design to your style as well as you can renew individual parts to refresh the look or just prolong longevity - in interest of your economy or environmental footprint.

Perfect for reading, relaxing, or sleeping, Rollo offers the perfect balance of style and flexibility for compact living spaces.

Design by Flemming Højfeldt & Per Weiss

For product details see page 161 or scan the QR code.



# ZEAL FAMILY

## CUSTOMIZABLE COMPACT COMFORT

The Zeal family combines compact design with exceptional adaptability, making it the ultimate daybed for modern living. With three adjustable positions and a pocket spring base for unparalleled comfort.

Choose from four leg designs—Bow, Laser, Styletto, or Straw—each adding a distinct style to the compact frame. Perfect for small spaces, Zeal combines ergonomic design with customizable elegance, offering a stylish and functional solution for modern living.

Page 062: Zeal Styletto, Zeal Bow & Zeal Laser

Page 063: Zeal Straw

Design by Per Weiss

For product details see page 152 or scan the QR codes.



Zeal Styletto



Zeal Bow



Zeal Laser



Zeal Straw



Shown in: 510 Elegance, Orange | Straw legs





## GHIA CHROME SILVERSHINE

### REFLECTIVE ELEGANCE

Ghia Silvershine elevates the classic daybed with shimmering metallic fabric and sleek chrome legs. Its avant-garde design amplifies light, adding a touch of modern luxury to any space. The bold aesthetic is paired with a streamlined silhouette, making it perfect for chic and daring interiors. Adjustable backrests provide personalized comfort, ideal for lounging or sleeping. Ghia Silvershine is a striking centerpiece that brings both style and substance to contemporary living.

Design by Per Weiss

For product details see page 150 or scan the QR code.



# GHIA CHROME

## MULTIFUNCTIONAL EUROPEAN MODERNISM

The Ghia Chrome daybed pays tribute to European modernism and the Bauhaus school with its sleek chrome legs and classic upholstery, exuding industrial sophistication. Its distinctive design combines minimalist aesthetics with adaptable functionality, featuring a three-step elevation system on both sides for personalized comfort - whether seated, reclining, or lying flat. With a generous 80x210 cm bed size, it is well-suited for relaxation or accommodating overnight guests. Ghia Chrome's refined design and polished details make it an ideal choice for urban interiors that prioritize style and versatility.

Design by Per Weiss

For product details see page 150 or scan the QR code.





## GHIA LASER

### VERSATILE DAYBED WITH INDUSTRIAL ELEGANCE

The Ghia Laser daybed is a masterpiece of industrial styling and functionality. Supported by striking black lasercut metal legs, it adds a modern edge to any interior. Both sides feature a three-step elevation system, enabling you to adjust for sitting, lounging, or reclining comfortably. Its generous 80x210 cm bed size offers excellent space for daytime use or hosting overnight guests. Ghia Laser blends practicality with contemporary design, creating a versatile centerpiece that fits seamlessly into modern living while delivering a bold, polished aesthetic.

Shown in: 550 Faunal, Black

Design by Per Weiss

For product details see page 150 or scan the QR code.



## GHIA WOOD

### SOLID SCANDINAVIAN CRAFTSMANSHIP

The Ghia Wood is a versatile daybed that embodies the essence of Scandinavian design. Its solid oak legs, both sturdy and elegant, pay tribute to traditional craftsmanship while blending seamlessly with industrial-inspired styling and timeless functionality. Equipped with a three-step elevation system on both sides, it effortlessly transitions between seating, lounging, and reclining positions. With a generous 80x210 cm bed size, it offers exceptional comfort for relaxation or accommodating guests. Perfect for modern living, the Ghia Wood combines practicality with sophisticated design, making it a multifunctional piece that enhances any contemporary space with elegance and adaptability.

Shown in: 318 Cordufine, Beige

Design by Per Weiss

For product details see page 150 or scan the QR code.



# ENVIRONMENTAL CONSIDERATIONS



Plant trees

We contribute to the balance of the global ecosystem by planting more than 10.000 trees every year to compensate for our consumption of wood.



Prioritizing recycled materials

We thoughtfully select all materials, considering their overall quality and the sustainability profile of the product.

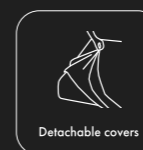

Detachable covers

A growing part of our collection comes with detachable and washable covers.



FSC®-certified

Our production facilities are FSC®-certified.

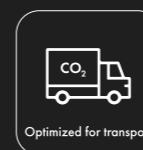

Optimized for transport

Our designs and packaging are optimized to ensure minimized CO<sub>2</sub> emissions in relation to transport and storage.



Design for disassembly

Our design strategy allows for easy replacement of components to prolong a product's life cycle.

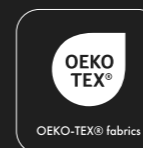

OEKO-TEX® fabrics

Our fabrics and foams are OEKO-TEX® certified. OEKO-TEX® is one of the world's best-known labels for testing harmful substances, ensuring these are excluded from the products and guaranteeing customer confidence and high product safety.

5  
YEAR

Warranty

We offer a 5-year warranty on all designs and a lifetime warranty on slats and gears for sofa beds in the Multifunctionals category. See guidelines and terms at [www.innovationliving.com](http://www.innovationliving.com)

# PURI

## DESIGNED FOR LONGEVITY

The Puri daybed combines sleek aesthetics with functional versatility. Its streamlined frame features an integrated walnut or oak tabletop, providing a convenient spot for books, decor, or essentials. Crafted for lasting comfort, it includes high resilient foam and removeable, washable covers, ensuring it stays fresh over time. The clean design complements various decor styles, from minimalist to contemporary, making it a versatile addition to any interior.

Optimized for disassembly and recycling, Puri is stylish yet crafted with sustainability in mind, offering a functional resting space that seamlessly fits into modern homes.

Shown in: 536 Bouclé, Ochre | Table top in walnut

Design by Per Weiss

For product details see page 153 or scan the QR code.



# NEWILLA WITH LOUNGER

## VERSATILE DESIGN FOR CONTEMPORARY LIVING

The Newilla Lounger combines modern design with everyday practicality. Its interchangeable lounger can be positioned on either side, adapting effortlessly to your space. Large storage compartments beneath the sofa and lounger keep essentials neatly organized and within reach. The smooth lift-out mechanism effortlessly transforms it into a comfortable bed. With detachable, washable covers for easy maintenance, its voluminous shape and clean lines enhance both style and functionality. Perfect for modern living, Newilla Lounger offers a seamless blend of comfort and adaptability.

Design by Per Weiss

For product details see page 158 or scan the QR code.



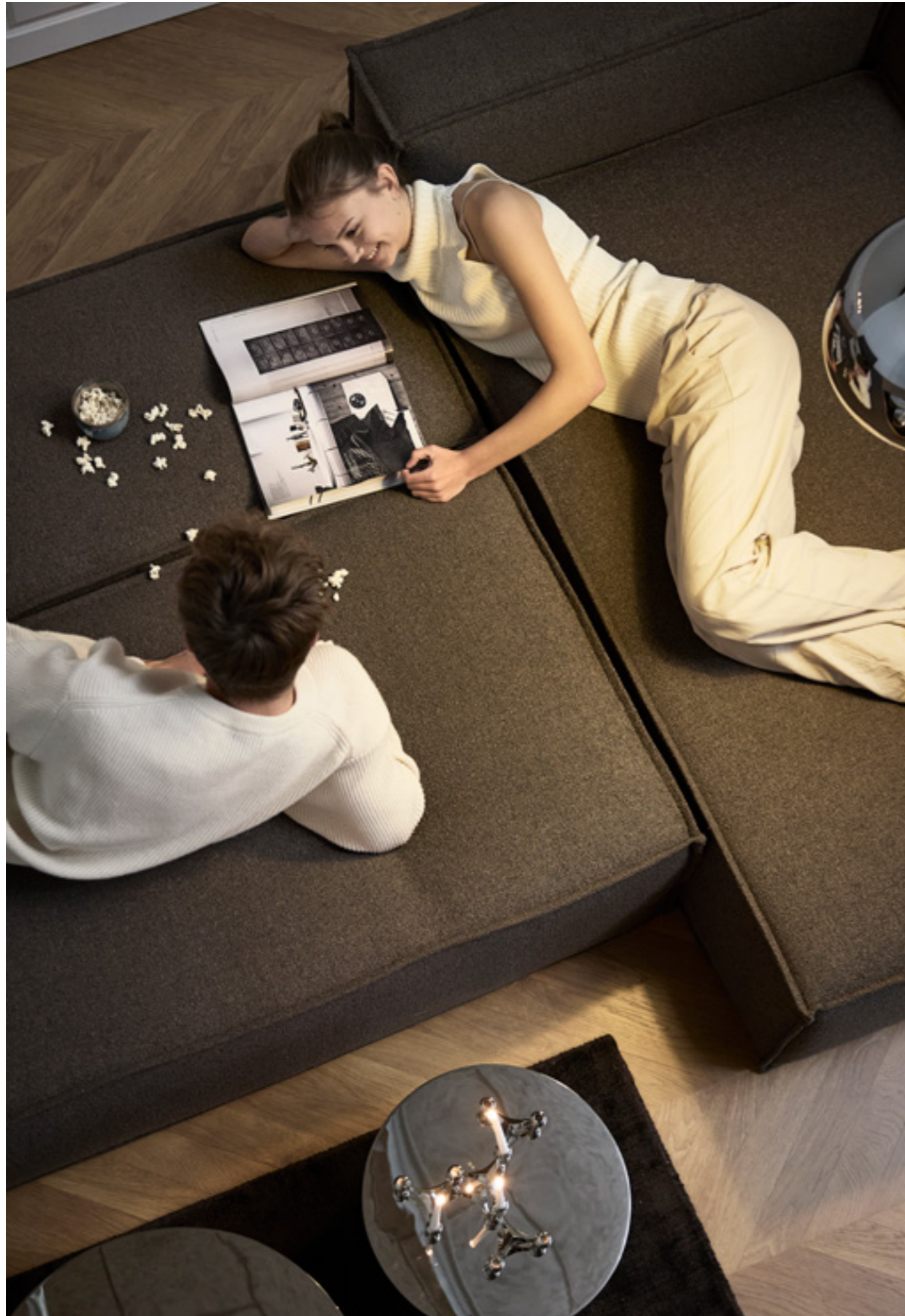

**Did you know:**

Place the sofa against the wall, fold out the bed, and place the cushions to make up a large lounge space for ultimate relaxation.

The left-right reversible lounge adapts to any room layout. With a detachable, washable cover for easy maintenance, Newilla with Lounger is the ideal choice for modern homes seeking a blend of style and functionality.





# NEWILLA

## TRENDY DESIGN WITH EVERYDAY PRACTICALITY

Newilla is a voluminous sofa with wide, stylish armrests, adding a contemporary touch to your living space. Perfect for those who prioritize both aesthetics and comfort, its oversized design stands out. Effortlessly transforming from a sofa to a spacious bed in seconds, Newilla offers flexibility for hosting guests or enjoying relaxing afternoons.

Adding to its functionality, Newilla includes a bedding box that offers a discreet storage solution, keeping your space clutter free and essentials close at hand.

With a detachable, washable cover for easy maintenance, Newilla is the ideal choice for modern homes seeking a blend of style and functionality.

**Design by Per Weiss**

For product details see page 158 or scan the QR code.



Shown in: 357 Taura, Off White | Tin Drum table see page 134



# MALLOY

## EFFORTLESS STYLE WITH THOUGHTFUL DETAILS

Seamlessly blending elegance, comfort, and practicality, Malloy is designed to bring comfort and functionality to your home. Feather-filled cushions provide luxurious seating, while flexible armrest pillows offer personalized support for ultimate relaxation. Set on slim metal legs, Malloy achieves a modern, airy aesthetic. With its low seat height and generous seat depth, Malloy is a true lounge sofa. The center pull-down seat creates the illusion of two large seat cushions, adding a unique design element without sacrificing comfort or functionality. Easily transforming into a functional bed, Malloy is the perfect choice for those seeking a stylish and functional centerpiece for their home.

Design by Per Weiss

For product details see page 153 or scan the QR code.



# MALLOY WOOD

## THE PERFECT SOFA FOR MODERN LIVING

Malloy Wood blends timeless design with functional elegance. Solid oak armrests add warmth and sophistication, while feather-filled cushions ensure a cozy and relaxing experience. Integrated neck cushions provide extra support, perfect for lounging.

With its blend of quality, style, and functionality, Malloy Wood is an ideal choice for contemporary homes seeking Scandinavian craftsmanship and unique comfort.

Design by Per Weiss, Oliver & Lukas WeissKrogh  
For product details see page 153 or scan the QR code.





# ENVIRONMENTAL CONSIDERATIONS

## Give back to nature

To support the balance of the global ecosystem, Innovation Living plants over 10,000 new trees annually to offset our wood consumption.

## Detachable covers

Recognizing the clear advantages, an increasing portion of our collection features detachable and washable covers. The sofas marked with the “Detachable covers” symbol are designed for easy maintenance, with covers that can be machine washed at 30 degrees Celsius. Additionally, upholstery can be replaced when worn or simply to refresh the sofa’s appearance. This approach allows you to update your sofa without the need for a full replacement, significantly reducing environmental impact.

## Products available with detachable covers:

Aslak, Balder, Colpus, Fraction, Idun, Junus, Lomira, Minimum, Newilla, Newilla with lounger, Pauke, Puri, Rollo, Soft Peak, Trym and Yonata.

Look for the detachable covers icon in the Collection overview and specifications section pages 142-161.

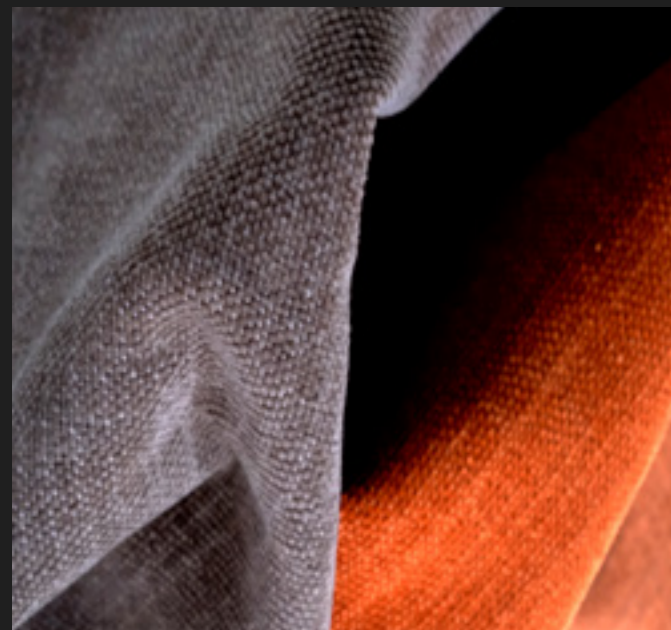

## Fabrics

For designs where removable covers are not feasible, fabric durability and ease of cleaning are essential to ensuring long-lasting quality. To enhance resilience, all fabrics are crafted to be highly durable and are further reinforced with backing materials. All fabrics, except Faunal and Silvershine, are engineered to withstand washing at 30 degrees Celsius, enabling effective wet cleaning. Additionally, all fabrics meet the OEKO-TEX® Standard 100 certification, guaranteeing they are free from harmful substances.

## Recycled fabrics

The availability of fabrics made from recycled fibers is steadily growing, and we are continually exploring the innovative and exciting new options. We encourage you to take a look at our Bouclé and Esina fabric selections for recycled options — details can be found on pages 162-163

## Lower CO<sub>2</sub> footprint

Since 1989, all our products have been designed for flat packing, which minimizes CO<sub>2</sub> emissions during transportation and storage. We continuously work to reduce the environmental impact of our activities, and you can read more about our specific initiatives on our website. Although we are not CO<sub>2</sub> neutral, we are committed to minimizing our CO<sub>2</sub> footprint.

## Maintain and refresh

Designing for flat packing involves creating a set of components that can be easily assembled into a complete product. While the complexity and number of parts may differ between products, this design approach enables straightforward replacement of individual components. This not only extends the product’s life cycle—by allowing for the replacement of worn-out parts or updating its appearance—but also supports sustainability and practicality.

## Disassembly and recycling

Our design process prioritizes the disassembly of products and materials at the end of their life cycle. We thoughtfully select materials, determine optimal methods for combining them, and try to ensure they can be separated into individual components for recycling. Each design poses unique challenges, with some being more conducive to disassembly than others. Nevertheless, moving in a more sustainable direction remains an important part of our design philosophy, and the environmental impact is carefully considered in every product we create.



## Certified production facilities

We are committed to supporting the development of local communities, contributing to a better future in the regions where we operate. To ensure continuous improvement, our production facilities are regularly audited to verify compliance with our group values and adherence to established working conditions, as outlined by third-party standards like the amfori BSCI Code of Conduct. Furthermore, our production facilities follow amfori BEPI standards and are FSC®-certified, reflecting our dedication to responsible and sustainable practices.

For more information about our standards and principles, please visit our website.

# OSVALD & CORNILA

## MODERN DESIGN MEETS SMART STORAGE

Osvald and Cornila combine sleek design with practical functionality, creating the perfect duo for contemporary living spaces. Osvald offers a stylish look and effortlessly converts from a sofa to a spacious bed, ideal for hosting guests. Cornila complements it with additional seating and a both the sofa and pouf have a hidden bedding box for extra storage. Together, they deliver an elegant and adaptable setup that blends clean aesthetics with smart, space-saving features, making them an excellent choice for modern homes.

Design by Emil Højfeldt & Per Weiss  
 For product details see page 155 or scan the QR code.



# CONE

## COMFORTABLE SOFA WITH A REFINED, ROUNDED SILHOUETTE

Cone combines elegant design with exceptional comfort. Fully upholstered arms and plush cushions ensure a cozy seating experience, while a spacious storage box beneath the sofa keeps essentials organized and accessible. Effortlessly converting from sofa to bed with auto-fold legs, Cone provides sturdy support for overnight guests. Its generous size and inviting design create the perfect lounge area - simply fold out the bed and arrange the cushions for ultimate relaxation. With its blend of style, practicality, and comfort, Cone is a standout addition to any modern living space.

Design by Emil Højfeldt & Per Weiss

For product details see page 155 or scan the QR code.

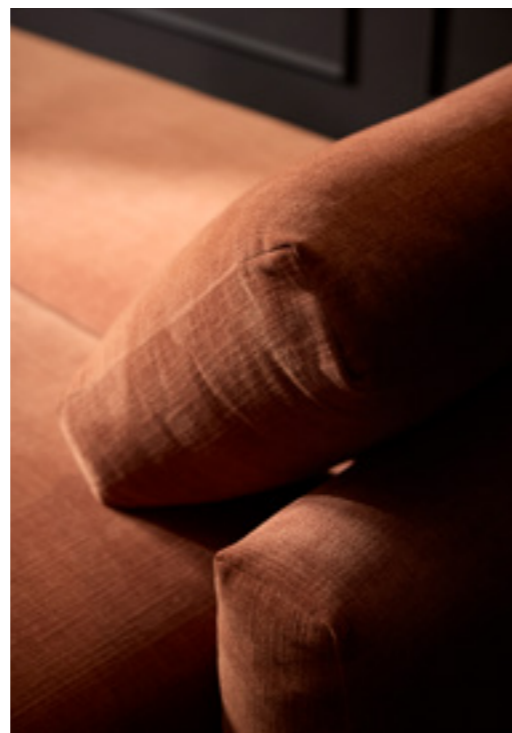

# YONATA

## MODERN SIMPLICITY WITH FUNCTIONAL DESIGN

Yonata combines minimalist aesthetics with practical functionality. Featuring sleek black metal legs and a streamlined silhouette, it exudes understated elegance. Perfect for central placement, its upholstered backrest ensures comfort and visual harmony from all angles. Compact and versatile, Yonata is ideal for urban living, while its detachable, washable covers ensure easy maintenance. Thoughtfully designed to complement a variety of interiors, Yonata offers a stylish and functional addition to modern homes.

Design by Emil Højfeldt & Per Weiss

For product details see page 158 or scan the QR code.



# EILIS

## UNDERSTATED BEAUTY WITH SMART AND PRACTICAL DETAILS

Eilis celebrates understated elegance and draws inspiration from late sixties and early seventies upholstery design, showcasing a distinctive soft quilted texture that adds depth and comfort. Designed for multifunctional living, Eilis seamlessly transforms from a sofa into a cozy bed, while a built-in bedding box discreetly stores linens. Its soothing tones complement both contemporary and classic interiors. Its thoughtful design merges retro charm with modern functionality, making it a standout piece for any interior.

Design by Per Weiss  
 For product details see page 158 or scan the QR code.



Shown in: 280 Avella, Sand



# RECAST

## TIMELESS DESIGN AND FUNCTIONALITY

Recast merges mid-century elegance with versatile functionality. Its button-tufted upholstery, dark oak legs and optional walnut veneer arms offer a refined, stylish aesthetic. Effortlessly converting into a double or single bed, it is ideal for hosting guests or as spot to lounge. A hidden bedding box provides convenient storage, while the durable metal frame ensures lasting comfort. Perfect for compact spaces, Recast combines timeless charm with practicality, elevating modern interiors with its sophisticated design.

Design by Per Weiss

For product details see page 156 or scan the QR codes.



Without arms



With arms



Shown in: 357 Taura, Off White & walnut veneer arms



# SLY

## STREAMLINED DESIGN AND VERSATILE FUNCTIONALITY

Sly combines minimalist aesthetics with modern practicality. Its understated design makes it an ideal choice for guest rooms and spare bedrooms, offering both style and practicality in one compact piece. The black metal legs add an industrial touch to its sleek profile. The pocket spring base delivers excellent comfort for both sitting and sleeping. With easy conversion and a bedding box for added storage, Sly is a stylish and functional solution for contemporary living.

Design by Per Weiss

For product details see page 157 or scan the QR code.



Shown in: 359 Taura, Cappuccino

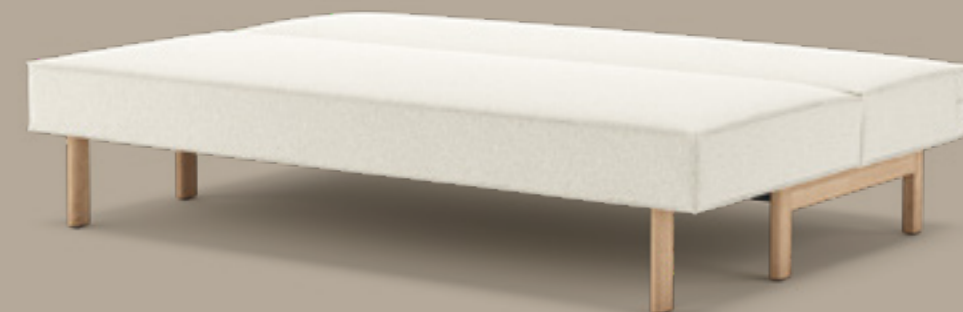

# SLY WOOD

## EXCELLENT COMFORT - WITH A NATURAL TOUCH

Sly Wood combines sleek design with Scandinavian warmth, featuring solid oak legs that gives it a Nordic design profile. Effortlessly transitioning between a single and double bed, it is perfect for compact living. The pocket spring system ensures optimal comfort, while the hidden bedding box provides practical storage for linens. Blending understated elegance with versatility, Sly Wood offers a timeless and functional solution for modern, urban homes.

Shown in: 527 Mixed Dance, Natural

Design by Per Weiss

For product details see page 157 or scan the QR code.





Shown in: Sigga X is only available in 300 Weda, Sand | Tin Drum table see page 134



## SIGGA X

### MULTIFUNCTIONAL COMFORT WITH ELEGANT DETAILS

Sigga X blends modern design with versatile functionality. Its clean lines and decorative stitching create a refined aesthetic, while the pocket spring mattress and two soft back cushions ensure superior comfort for lounging or sleeping. The hidden bedding box offers practical storage for linens, and the matte black steel legs add contemporary elegance. Easily convertible, Sigga X transitions seamlessly from sofa to daybed or double bed. A perfect balance of style, comfort, and storage, Sigga X is an excellent addition to any modern home.

Design by Per Weiss

For product details see page 153 or scan the QR code.



A close-up photograph of a wooden chair joint, showing a cylindrical leg and a rectangular seat or backrest piece joined together. The wood is light-colored with a visible grain. The lighting is dramatic, highlighting the texture and the precision of the joinery against a dark background.

## CRAFTSMANSHIP, QUALITY AND LONGIVITY

Beyond design, we prioritize exceptional craftsmanship and high quality materials, ensuring timeless aesthetics and reliable performance. Our mission is to create long-lasting products that seamlessly combine functionality and beauty.

For over 30 years, flatpack design has been at the core of our ethos, reflecting our commitment to sustainability, efficiency, and durability. This approach reduces CO2 emissions, optimizes storage, and minimizes transport-related damages.

Flatpack design also drives innovation through modular components, enabling easy assembly, maintenance, and repair, while readily available spare parts extend product life and promote sustainable consumption.

# AKELLO

## FLEXIBLE DESIGN MEETS TIMELESS COMFORT

The Akello sofa bed brings modern elegance and functional design into one compact piece. Its channel-stitched upholstery exudes sophistication, while the 140x200 cm bed ensures restful nights with nozag spring support. Auto-fold legs provide hassle-free conversion from sofa to bed. A spacious hidden storage compartment keeps linens and essentials tidy, adding practicality. Optional armrests let you customize Akello to suit your comfort needs. With its sleek design and innovative features, Akello is the perfect sofa bed for contemporary spaces that value both style and utility.

Design by Per Weiss

For product details see page 154 or scan the QR code.



Shown in: 280 Avella, Sand



Shown: Akello lounge in 280 Avella, Sand

### AKELLO FAMILY



AKELLO



AKELLO WITH ARMS



AKELLO LOUNGER

Lounger is left/right reversible



AKELLO LOUNGER WITH ARMS

Lounger is left/right reversible



Akello



Akello with arms



Akello lounge



Akello lounge with arms

Design by Per Weiss  
For product details see page 154 or scan the QR codes.

# AKELLO LOUNGER WITH ARMS

## MODULAR COMFORT AND INTEGRATED STORAGE

The Akello Lounger with arms merges modern aesthetics and versatile design. Its 140x200 cm bed, enhanced by channel stitching and a no-zag comfort system, ensures both elegance and support. The lounger can be positioned on the left or right, adapting to your space. Beneath the seat lies a spacious storage room, perfect for keeping essentials within reach. The auto-fold legs enable smooth transformation between configurations. Practical yet sophisticated, the Akello Lounger is an ideal solution for stylish, multifunctional living.

Design by Per Weiss

For product details see page 154 or scan the QR code.



# IDUN & TRYM

## SCANDINAVIAN ELEGANCE MEETS FUNCTIONALITY

Embrace the Scandinavian spirit with Idun and Trym, two versatile sofa beds that seamlessly blend timeless design with modern practicality. Idun features a sleek silhouette, broad armrests, and oak legs, exuding refinement and approachability. Trym, on the other hand, brings youthful energy with its clean lines, understated form, and natural wooden legs. Its minimalist design radiates lightness and warmth, making it a stylish focal point for modern spaces.

Oversized cushions provide plush comfort, while the sofa easily converts into a double or single bed by removing the cushions. A hidden bedding box offers convenient storage for essentials, and removable, washable covers ensure easy maintenance. Both Idun and Trym reflect Nordic craftsmanship, balancing form and function to elevate any living space.

Trym shown in: 539 Bouclé, Beige

Design by Per Weiss

For product details see page 157 or scan the QR codes.



Idun



Trym



## WE OFFER A 5 YEAR WARRANTY

Our products are made to last, with a focus on longevity, premium materials, and rigorous testing processes to ensure exceptional quality.

We offer a 5-year warranty on all designs and a lifetime warranty on slats and gears for sofa beds in the Multifunctionals category. By registering your product at our website, you can upgrade your warranty to 5 years. For more information, including warranty guidelines and terms, please visit [www.innovationliving.com](http://www.innovationliving.com)



# PYXIS D.E.L.

## SCANDINAVIAN DESIGN MEETS SUPERIOR COMFORT

Pyxis seamlessly combines Scandinavian elegance with everyday functionality. Its Deluxe Excess Lounger design offers deep seating and plush, feather-filled cushions for exceptional comfort. Slim arms and lacquered oak legs create a minimalist yet sophisticated look that enhances both modern and classic interiors. Pyxis effortlessly transforms into a spacious double bed or a cozy single bed by simply removing the cushions. Perfect for contemporary homes, Pyxis blends timeless style, superior comfort, and practical functionality, making it a standout choice for those seeking elegance and adaptability.

Design by Per Weiss

For product details see page 155 or scan the QR code.



# SUPREMAX D.E.L. & CASSIUS D.E.L.

## EFFORTLESS ELEGANCE, DAY AND NIGHT

Cassius and Supremax seamlessly blend luxury and functionality to elevate any contemporary living space. Cassius stands out with its wide armrests, tufted upholstery, and spacious seating, serving as a luxurious centerpiece. In contrast, Supremax offers a minimalist aesthetic with streamlined elegance, perfect for modern interiors.

Both sofa beds easily transition from sofa to a large 155x200 cm bed, featuring pocket spring mattresses for superior comfort. With or without arm rests you can decide which design suits your style. Cassius and Supremax provide a flawless combination of sophistication, adaptability, and practicality.

Supremax shown in: 565 Twist, Granite

Design by Per Weiss

For product details see page 156 or scan the QR codes.



Cassius



Supremax



## BIFROST D.E.L.

### LUXURY WITH SCANDINAVIAN TOUCH

The Bifrost seamlessly blends Scandinavian design with practical adaptability. Featuring deep seating and cushions filled with a feather fiberfill mix, it delivers exceptional comfort. Black-stained wood armrests add a touch of timeless sophistication, enhancing its refined aesthetic. Effortlessly transforming into a single or large double bed, Bifrost caters to your needs with ease. Perfect for contemporary interiors, it combines style and functionality, creating a relaxing and versatile retreat for any living space.

Design by Per Weiss

For product details see page 155 or scan the QR code.



# DESIGN IT YOURSELF IN 4 EASY STEPS

## Step 01: Choose design and size



## Step 02: Choose comfort



**Classic**  
Firmness rating: Firm  
Mattress sizes: 120 / 140 x 200 cm.

Made from recycled foam, the Classic mattress is durable and provides a high degree of support for a comfortable sleep. Our high density foam provides strong motion isolation, making it easy to share the mattress. Choose our Classic mattress for a firm comfort.



**Latex**  
Firmness rating: Medium  
Mattress size: 140 x 200 cm.

A breathable natural core of high quality OEKO-TEX® latex ensures a durable mattress that adjusts to your body. Latex sleeps cooler than foam and reacts instantly to your every move. Choose our Latex mattress for a medium comfort.



**Spring**  
Firmness rating: Soft  
Mattress sizes: 120 / 140 x 200 cm.

The spring mattress is characterized by the soft comfort combined with effective pressure relief. Furthermore, the combination of fiberfill, a thin layer of foam, and the pocket springs ensure that the mattress is breathable and able to conduct moisture and heat away at night.

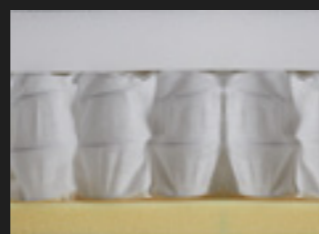

**Soft Spring**  
Firmness rating: Extra soft  
Mattress sizes: 120 / 140 x 200 cm.

The Soft Spring mattress offers a unique comfort achieved through the combination of pocket springs and the built in topper of hyper soft foam. Choose our Soft Spring mattress for an extra soft comfort.

## Step 03: Choose styling



**Nordic Mattress (Fixed)**

This is the standard mattress look with pull downs. You decide the textile you like, and should you later happen to change your mind about style or color, you can choose between the two detachable cover options we offer.



**Nordic Cover (Detachable)**

This cover has a sleek, rounded surface with stylings in each of the corners of the mattress. It covers up your entire mattress, giving you the option of choosing a different color. Should you want to change the look, simply buy a new cover instead of a new mattress.

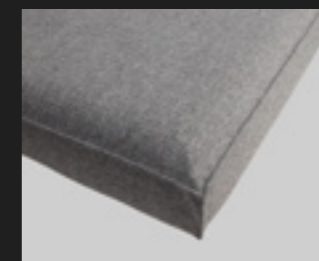

**Sharp Plus Cover (Detachable)**

This cover has a sleek surface with stylings across the edges of the mattress. It covers up your entire mattress, giving you the option of choosing a different color. Should you want to change the look, simply buy a new cover instead of a new mattress.

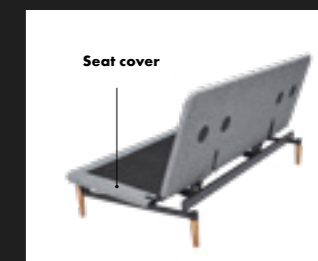

**Optional seat cover**

A back frame cover is always included. If you prefer the full cover look, a seat frame cover can be purchased.

## Step 04: Choose fabric

### Fabrics

Discover our collection of handpicked fabrics, each chosen with precision to offer a versatile range of options. Whether you are drawn to classic simplicity or modern boldness, our selection provides fabrics to complement any personal style. From timeless neutrals to rich, eye-catching shades, you will find colors that inspire creativity and individuality. Every fabric in our collection is OEKO-TEX®-certified. Experience the perfect combination of variety, elegance, and conscious craftsmanship in every choice.

View our fabric collection on page 163, or go online to use our 3D visualizer.

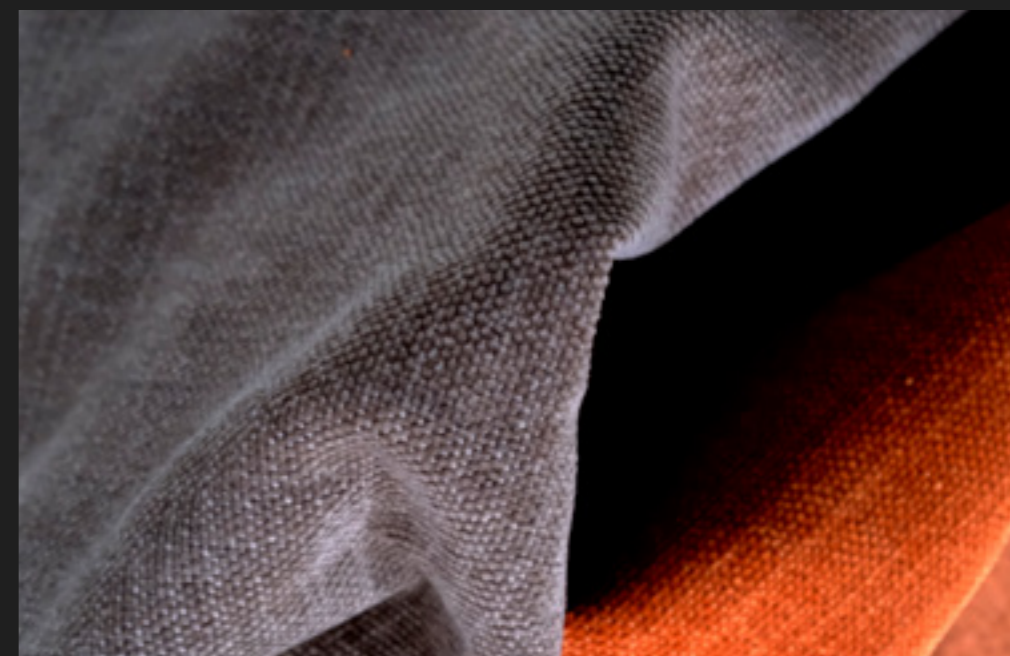

# MINIMUM STRIPE

## MODERN MINIMALISM WITH A BOLD TOUCH

The Minimum Stripe sofa bed merges minimalist design with striking visual impact. Its bold black-and-white stripes and sleek chrome legs create a statement piece for contemporary interiors. Designed for adaptability, it features a four-step head elevation and two backrest positions, effortlessly adjusting to your preferences. A hidden bedding box offers discreet storage, while the detachable, washable cover ensures easy upkeep. Combining eye-catching style with versatile functionality, Minimum Stripe delivers modern comfort with a distinctive flair.

Shown in: Special edition Stripe fabric | Nordic Cover & seat cover | Available for all Multifunctionals | Geobau table see page 134

Design by Peter Henriksen & Per Weiss

For product details see page 160 or scan the QR code.



# ASLAK

## MODERN COMFORT WITH SCANDINAVIAN ROOTS

Aslak combines Scandinavian charm with versatile functionality, making it a perfect addition to contemporary living spaces. Its single-piece seat and backrest create a seamless aesthetic, while solid oak legs provide sturdy support and a natural touch that complements its minimalist design. With a four-step head elevation system and two reclining back positions, Aslak transitions effortlessly between sofa and bed modes. A hidden bedding compartment adds practical storage for blankets and pillows. Built to last, it features durable gears and slats backed by a lifetime warranty and a superior comfort by the use of high quality materials.

Design by Per Weiss, Oliver & Lukas WeissKrogh  
For product details see page 159 or scan the QR code.



Shown in: 358 Taura, Chocco | Nordic Mattress & seat cover





## BALDER

### TIMELESS DESIGN FOR EVERYDAY LIVING

Balder seamlessly blends Scandinavian elegance with practical functionality. The undivided mattress is complemented by solid oak arms that add warmth and Scandinavian character.

Designed for versatility, Balder features two backrest positions and four head elevation levels, adapting effortlessly for sitting, lounging, or sleeping. A hidden bedding box provides discreet storage, keeping essentials close at hand.

Balder combines lasting style and everyday practicality, making it a perfect fit for modern living spaces.

Design by Per Weiss, Oliver & Lukas WeissKrogh  
For product details see page 159 or scan the QR code.



# LOMIRA

## FUNCTIONAL ELEGANCE IN A TRENDY DESIGN

Lomira brings sleek sophistication to multifunctional living with its reflective chrome arm rests and minimalist aesthetic, while its four-step head elevation and reclining backrest provide customizable comfort. Effortlessly transitioning between sofa, lounge, and bed modes, Lomira adapts seamlessly to your lifestyle. A hidden bedding box adds practical storage, and its detachable, washable cover ensures hassle-free maintenance. Backed by a lifetime guarantee on its durable gears and slats, Lomira combines lasting reliability with modern style, making it perfect for versatile living spaces.

Design by Per Weiss

For product details see page 159 or scan the QR code.







Shown in: 411 Esina, Cedar Brown | Sharp Plus Cover & seat cover

# JUNUS

## THE MODERN SOFA BED SOLUTION

Junus blends contemporary design with plush comfort and adaptability. Its tall, inviting pillow arms and sleek matte black steel legs deliver a modern yet cozy aesthetic. Offering two backrest positions and a four-step adjustable headrest, Junus ensures personalized comfort for sitting, lounging, or sleeping. A hidden bedding box provides convenient storage, while durable gears and slats guarantee long-lasting reliability. Perfect for modern living spaces, Junus combines style, functionality, and comfort in one versatile solution.

Design by Per Weiss

For product details see page 159 or scan the QR code.





## COLPUS

### STYLE AND COMFORT IN PERFECT BALANCE

Colpus seamlessly unites timeless design with versatile functionality. Its sleek Styletto legs, available in lacquered oak or black lacquered oak, bring understated elegance to any interior. With a four-step head elevation and two backrest positions, Colpus adapts effortlessly for sitting, lounging, or sleeping. A spacious hidden bedding box offers practical storage, while the detachable, washable cover ensures easy maintenance and lasting freshness. Built to last with a lifetime guarantee on gears and slats, Colpus delivers a perfect balance of style, durability, and everyday practicality, making it an ideal choice for modern living spaces.

Shown in: 351 Taura, Slate Grey | Legs in lacquered oak | Nordic Mattress & seat cover

Design by Per Weiss

For product details see page 160 or scan the QR code.



## FRACTION

### INDUSTRIAL ELEGANCE

Fraction combines sleek aesthetics with practical functionality, making it ideal for compact living spaces. Its minimalist design, supported by black metal legs, seamlessly complements contemporary interiors. With a four-step head elevation and two reclining positions, Fraction adapts effortlessly for lounging, sitting, or sleeping. Easily converting into a bed, it also features a spacious bedding box for convenient storage. A detachable, renewable cover ensures lasting freshness, while durable gears and slats, backed by a lifetime guarantee, provide reliable performance. Fraction is designed to offer style, comfort, and longevity in one compact solution.

Shown in: 412 Esina, Rust Orange | Nordic Cover & seat cover

Design by Per Weiss

For product details see page 160 or scan the QR code.





Shown in: 510 Elegance Orange and special edition Stripe fabric



**VIKKO CHAIR & VIKKO CHAIR WITH ARM**  
STRIPE SPECIAL

Available stocked combinations with 2-4 weeks' delivery time | Seat in 510 Elegance Orange, 511 Elegance Red or 512 Elegance Ultramarine | Backrest in special edition Stripe fabric | For specifications please see page 138



**DAPPER, ELLIPSE & ROLL CUSHIONS**  
STRIPE SPECIAL

Special edition Stripe fabric | For specifications please see page 136

**BUTT BEAN BAG & PAUKE POUFS**  
STRIPE SPECIAL

Available stocked combinations with 2-4 weeks' delivery time | Top/bottom in 510 Elegance Orange, 511 Elegance Red or 512 Elegance Ultramarine | Side in special edition Stripe fabric | For specifications please see page 137





### GEOBAU TABLES

A vibrant statement piece with bold colors, high-gloss finish, and circular cut-outs. Compact and functional, it offers storage and durability, blending playful design with modern decor. Size: 33 × 33 × 33 cm. Available in ultramarine, traffic red, pure orange, glossy black, or grey white.

Design by Per Weiss 2024



### TIN DRUM TABLES

A sleek, mirror-finished centerpiece that reflects light, creating a sense of space and luxury. Available in three sizes, it pairs modern minimalism with durable metal construction, ideal as a coffee, side, or accent table.

Sizes: Ø25 × 50 cm, Ø40 × 35 cm & Ø60 × 30 cm



### TRAVERTINA TABLES

Elegant tables showcasing the natural beauty of travertine stone with unique veining and soft neutral tones. Durable and versatile, available in three sizes for standalone use or layered arrangements, can be turned around, standing or laying down perfect for minimalist or contemporary spaces.

Sizes: 25 × 25 × 50 cm, 40 × 40 × 35 cm & 60 × 40 × 30 cm

### NORDIC TABLES

Combine table tops with Nordic legs in lacquered oak, see options below.

#### Medium

Top in lacquered oak veneer or black stained oak veneer  
Ø45 cm | Legs 32,5 cm

#### Large

Top in lacquered oak veneer or black stained oak veneer  
Ø70 cm | Legs 40 cm

Design by Emil Højfeldt & Per Weiss



### KIFFA TABLES

The Kiffa table is a flexible and easily height adjustable table for any purpose.

Size Ø45 cm | Height 41 - 70 cm | Table base: Matt black steel Top in Lacquered oak veneer or black stained oak veneer.

Design by Emil Højfeldt 2017





### DAPPER CUSHIONS

Sizes: 50 × 50 cm, 65 × 65 cm, 40 × 60 cm and 50 × 80 cm | Detachable and washable cover | Feather mix inside | The detachable cover makes it possible to renew the cushion | See all fabric options, page 163



### SQUARE CUSHIONS

Size: 50 × 50 × 11 cm | Detachable and washable cover | Feather mix inside | The detachable cover makes it possible to renew the cushion | Recommended for Rollo daybed | See all fabric options, page 163



### SOFT PEAK BEAN BAG

Design by Innovation Living Design Office

Size: 105-135-80 cm | Detachable and washable cover | Volume: Inside 300 litres EPS Beads | Shown in Corduroy 594 Ivory | 2-4 weeks' delivery time | The detachable cover makes it possible to renew the bean bag. Can also be refilled. | See all fabric options, page 163

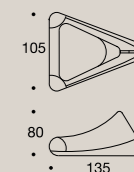

### ELLIPSE CUSHIONS

Size: 55 × 25 × 13 cm | Detachable and washable cover | Feather mix inside | The detachable cover makes it possible to renew the cushion | See all fabric options, page 163



### ROLL CUSHIONS

Size: Ø25 × 55 cm | Detachable and washable cover | Feather mix inside | The detachable cover makes it possible to renew the cushion | See all fabric options, page 163

### PAUKE POUFS

Design by Innovation Living Design Office

Sizes: Ø50 × 20 cm and Ø62 × 40 cm | Recycled foam | Detachable and washable cover | Shown in 539 Bouclé Beige & 536 Bouclé Ochre | Shown fabrics: 2-4 weeks' delivery time | Other fabric options with 4-6 weeks' delivery time, see page 163

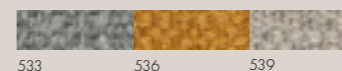
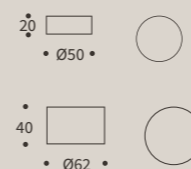

### HEADREST

Size: 25 × 60 cm | Detachable and washable cover | Inside is a foam core surrounded by a layer of fiberfill | The detachable cover makes it possible to renew the headrest | See all fabric options, page 163



Adjustable headrest available for: Akello, Bifrost, Cassius, Cone, Cubed, Eilis, Idun, Luoma, Neah, Newilla, Newilla with lounger, Olan, Oswald, Pyxis, Recast, Sigga X, Sly, Sly Wood, Supremax and Trym



### BUTT BEAN BAG

Design by Jesper Elg 2002

Size: Ø45 × H50 cm | Detachable and washable cover | Volume: Inside 100 litres EPS Beads | Shown in 536 Bouclé Ochre | 2-4 weeks' delivery time | The detachable cover makes it possible to renew the bean bag. Can also be refilled | See all fabric options, page 163

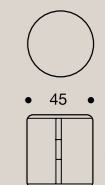



**VIKKO CHAIR & VIKKO CHAIR WITH ARMS**

Design by Emil Højfeldt & Per Weiss 2018, 2020

Legs in matt black steel | Shown in Corduroy 594 Ivory & Corduroy 595 Burnt Orange | Shown fabrics: 2-4 weeks' delivery time | Other fabric options with 6-8 weeks' delivery time, see page 163 | For product details scan the QR code

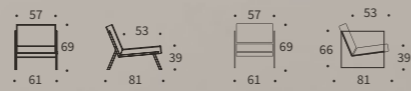
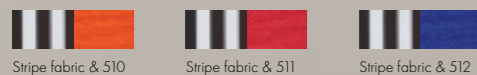

**INNO TOPPERS**

80 / 90 / 120 / 140 / 150 / 160 / 180 × 200 cm.  
A 5 cm durable and reversible top mattress with a core of hyper soft foam that provides an even and supportive sleeping surface on all adjustable sofa beds. The cover is 100% polyester which is breathable, removable and machine-washable at 60 degrees Celsius.

The top mattress comes with a bag for storage when not in use. The bag helps minimise the volume of the topper for better storage.



**MATTRESS PADS**

80 / 90 / 120 / 140 / 150 / 160 / 180 × 200 cm.

A mattress pad provides a little extra cushioning and an added layer of protection for your mattress. They can be removed and machine-washed at 60 degree Celsius. The fabric is OEKO-TEX® standard 100 certified.

Available for most mattresses.





## MEET US ON THE SOCIALS

Follow our social media channels if you need inspiration on how we can help you to expand your living space in style.



@innovationliving



@innovationliving



@innovationtm



@innovation-living



Scan the QR code for a direct link to your preferred social media platform.



**Pocket Spring**  
 Fabric  
 Fiberfill  
 High resilient foam  
 Pocket spring 10 cm  
 Fibertex  
 Metal mesh  
 Rigid metal frame

**Leg color options**  
 Lacquered oak    Smoked oak

**SPLITBACK FREJ | Design by Per Weiss, Oliver & Lukas WeissKrogh 2004, 2015 | Fabric options:** Shown stock fabrics, 2-4 weeks' delivery time | Other fabric options with 13-15 weeks' delivery time, see page 163 | Scan the QR code to see additional features at our website | **Look book:** See page 10

**Stock fabrics, 2-4 weeks' delivery time**





**Pocket Spring**  
 Fabric  
 Fiberfill  
 High resilient foam  
 Pocket spring 10 cm  
 Fibertex  
 Metal mesh  
 Rigid metal frame

**Leg color options**  
 Lacquered oak    Smoked oak

**SPLITBACK STEM | Design by Per Weiss 2004, 2015 | Legs:** Lacquered oak | **Fabric options:** Shown stock fabrics, 2-4 weeks' delivery time | Other fabric options with 13-15 weeks' delivery time, see page 163 | Scan the QR code to see additional features at our website

**Stock fabrics, 2-4 weeks' delivery time**





**Pocket Spring**  
 Fabric  
 Fiberfill  
 High resilient foam  
 Pocket spring 10 cm  
 Fibertex  
 Metal mesh  
 Rigid metal frame

**Leg color options**  
 Lacquered oak    Smoked oak

**SPLITBACK EIK | Design by Per Weiss, Oliver & Lukas WeissKrogh 2004, 2015 | Fabric options:** Shown stock fabrics, 2-4 weeks' delivery time | Other fabric options with 13-15 weeks' delivery time, see page 163 | Scan the QR code to see additional features at our website | **Look book:** See page 10

**Stock fabrics, 2-4 weeks' delivery time**





**Pocket Spring**  
 Fabric  
 Fiberfill  
 High resilient foam  
 Pocket spring 10 cm  
 Fibertex  
 Metal mesh  
 Rigid metal frame

**Leg color options**  
 Lacquered oak    Smoked oak

**SPLITBACK STEM WITH ARMS | Design by Per Weiss 2004, 2015 | Legs:** Lacquered oak | **Fabric options:** Shown stock fabrics, 2-4 weeks' delivery time | Other fabric options with 13-15 weeks' delivery time, see page 163 | Scan the QR code to see additional features at our website

**Stock fabrics, 2-4 weeks' delivery time**





**Pocket Spring**  
 Fabric  
 Fiberfill  
 High resilient foam  
 Pocket spring 10 cm  
 Fibertex  
 Metal mesh  
 Rigid metal frame

**Leg color options**  
 Lacquered oak    Dark lacquered oak    Black lacquered oak

**SPLITBACK STYLETTO | Design by Per Weiss 2004, 2014 | Fabric options:** Shown stock fabrics, 2-4 weeks' delivery time | Other fabric options with 13-15 weeks' delivery time, see page 163 | Scan the QR code to see additional features at our website

**Stock fabrics, 2-4 weeks' delivery time**





**Pocket Spring**  
 Fabric  
 Fiberfill  
 High resilient foam  
 Pocket spring 10 cm  
 Fibertex  
 Metal mesh  
 Rigid metal frame

**Leg color options**  
 Lacquered oak    Dark lacquered oak    Black lacquered oak

**SPLITBACK CHROME | Design by Per Weiss 2004 | Legs:** Chromed steel | **Fabric options:** Shown stock fabrics, 2-4 weeks' delivery time | Other fabric options with 13-15 weeks' delivery time, see page 163 | Scan the QR code to see additional features at our website

**Stock fabrics, 2-4 weeks' delivery time**







**Pocket Spring**  
 Fabric  
 Fiberfill  
 High resilient foam  
 Pocket spring 10 cm  
 Fibertex  
 Metal mesh  
 Rigid metal frame

**Leg color options**  
 Lacquered oak    Dark lacquered oak    Black lacquered oak

**SPLITBACK STYLETTO WITH ARMS | Design by Per Weiss 2004, 2014 | Fabric options:** Shown stock fabrics, 2-4 weeks' delivery time | Other fabric options with 13-15 weeks' delivery time, see page 163 | Scan the QR code to see additional features at our website

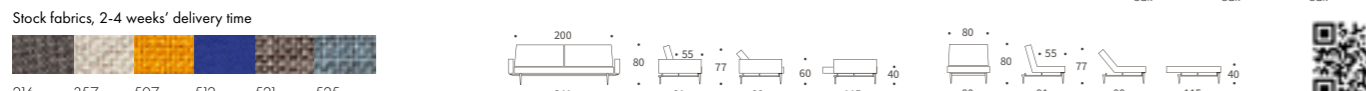
**Stock fabrics, 2-4 weeks' delivery time**

**Pocket Spring**  
 Fabric  
 Fiberfill  
 High resilient foam  
 Pocket spring 10 cm  
 Fibertex  
 Metal mesh  
 Rigid metal frame

**Leg color options**  
 Lacquered oak    Dark lacquered oak    Black lacquered oak

**SPLITBACK CHROME WITH ARMS | Design by Per Weiss 2004 | Legs:** Chromed steel | **Fabric options:** Shown stock fabrics, 2-4 weeks' delivery time | Other fabric options with 13-15 weeks' delivery time, see page 163 | Scan the QR code to see additional features at our website | **Look book:** See page 8

**Stock fabrics, 2-4 weeks' delivery time**







**Pocket Spring Dual**  
 Fabric  
 Fiberfill  
 High resilient foam  
 Fiberfill  
 Foam casing  
 Pocket spring 10 cm  
 Fibertex  
 Metal mesh  
 Rigid metal frame

**Leg color options**  
 Lacquered oak    Smoked oak

**DUBLEXO FREJ | Design by Per Weiss, Oliver & Lukas WeissKrogh 2011, 2015 | Fabric options:** Shown stock fabrics, 2-4 weeks' delivery time | Other fabric options with 13-15 weeks' delivery time, see page 163 | Scan the QR code to see additional features at our website

Stock fabrics, 2-4 weeks' delivery time  
 358    527    563



**Pocket Spring Dual**  
 Fabric  
 Fiberfill  
 High resilient foam  
 Fiberfill  
 Foam casing  
 Pocket spring 10 cm  
 Fibertex  
 Metal mesh  
 Rigid metal frame

**Leg color options**  
 Lacquered oak    Smoked oak

**DUBLEXO STEM | Design by Per Weiss 2011 | Legs:** Lacquered oak | **Fabric options:** Shown stock fabrics, 2-4 weeks' delivery time | Other fabric options with 13-15 weeks' delivery time, see page 163 | Scan the QR code to see additional features at our website

Stock fabrics, 2-4 weeks' delivery time  
 358    527    563



**Pocket Spring Dual**  
 Fabric  
 Fiberfill  
 High resilient foam  
 Fiberfill  
 Foam casing  
 Pocket spring 10 cm  
 Fibertex  
 Metal mesh  
 Rigid metal frame

**Leg color options**  
 Lacquered oak    Smoked oak

**DUBLEXO EIK | Design by Per Weiss, Oliver & Lukas WeissKrogh 2011, 2015 | Fabric options:** Shown stock fabrics, 2-4 weeks' delivery time | Other fabric options with 13-15 weeks' delivery time, see page 163 | Scan the QR code to see additional features at our website

Stock fabrics, 2-4 weeks' delivery time  
 358    527    563



**Pocket Spring Dual**  
 Fabric  
 Fiberfill  
 High resilient foam  
 Fiberfill  
 Foam casing  
 Pocket spring 10 cm  
 Fibertex  
 Metal mesh  
 Rigid metal frame

**Leg color options**  
 Lacquered oak    Smoked oak

**DUBLEXO STEM WITH ARMS | Design by Per Weiss 2011 | Legs:** Lacquered oak | **Fabric options:** Shown stock fabrics, 2-4 weeks' delivery time | Other fabric options with 13-15 weeks' delivery time, see page 163 | Scan the QR code to see additional features at our website

Stock fabrics, 2-4 weeks' delivery time  
 358    527    563



**Pocket Spring Dual**  
 Fabric  
 Fiberfill  
 High resilient foam  
 Fiberfill  
 Foam casing  
 Pocket spring 10 cm  
 Fibertex  
 Metal mesh  
 Rigid metal frame

**Leg color options**  
 Lacquered oak    Dark lacquered oak    Black lacquered oak

**DUBLEXO STYLETTO | Design by Per Weiss 2011 | Fabric options:** Shown stock fabrics, 2-4 weeks' delivery time | Other fabric options with 13-15 weeks' delivery time, see page 163 | Scan the QR code to see additional features at our website

Stock fabrics, 2-4 weeks' delivery time  
 358    527    563



**Pocket Spring Dual**  
 Fabric  
 Fiberfill  
 High resilient foam  
 Fiberfill  
 Foam casing  
 Pocket spring 10 cm  
 Fibertex  
 Metal mesh  
 Rigid metal frame

**Leg color options**  
 Lacquered oak    Dark lacquered oak    Black lacquered oak

**DUBLEXO CHROME | Design by Per Weiss 2011 | Legs:** Chromed steel | **Fabric options:** Shown stock fabrics, 2-4 weeks' delivery time | Other fabric options with 13-15 weeks' delivery time, see page 163 | Scan the QR code to see additional features at our website

Stock fabrics, 2-4 weeks' delivery time  
 358    527    563



**Pocket Spring Dual**  
 Fabric  
 Fiberfill  
 High resilient foam  
 Fiberfill  
 Foam casing  
 Pocket spring 10 cm  
 Fibertex  
 Metal mesh  
 Rigid metal frame

**Leg color options**  
 Lacquered oak    Dark lacquered oak    Black lacquered oak

**DUBLEXO STYLETTO WITH ARMS | Design by Per Weiss 2011 | Fabric options:** Shown stock fabrics, 2-4 weeks' delivery time | Other fabric options with 13-15 weeks' delivery time, see page 163 | Scan the QR code to see additional features at our website | **Look book:** See page 14

Stock fabrics, 2-4 weeks' delivery time  
 358    527    563





**Pocket Spring Dual**  
 Fabric  
 Fiberfill  
 High resilient foam  
 Fiberfill  
 Foam casing  
 Pocket spring 10 cm  
 Fibertex  
 Metal mesh  
 Rigid metal frame

**Leg color options**  
 Lacquered oak    Dark lacquered oak    Black lacquered oak

**DUBLEXO CHROME WITH ARMS | Design by Per Weiss 2011 | Legs:** Chromed steel | **Fabric options:** Shown stock fabrics, 2-4 weeks' delivery time | Other fabric options with 13-15 weeks' delivery time, see page 163 | Scan the QR code to see additional features at our website

Stock fabrics, 2-4 weeks' delivery time  
 358    527    563





**No-zag Spring**  
 Fabric  
 Fiberfill  
 High resilient foam  
 Fibertex  
 No-zag spring  
 Solid wood frame

**CUBED WOOD** | Design by Per Weiss, Oliver & Lukas WeissKrogh 2009, 2015 | Legs: Lacquered oak | Fabric options: Shown stock fabrics, 2-4 weeks' delivery time | Other fabric options with 6-8 weeks' delivery time, see page 163 | Scan the QR code to see additional features at our website | **Look book:** See page 16

Stock fabrics, 2-4 weeks' delivery time

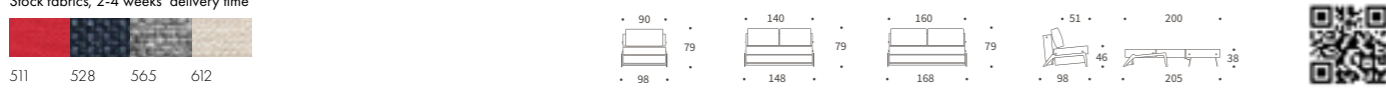

511 528 565 612

90 140 160 51 200  
 79 79 79 46 38  
 98 148 168 98 205

Bedding box Optional Headrest



**Double Spring**  
 Fabric cover  
 Fiberfill  
 High resilient foam  
 Pocket spring  
 No-zag spring  
 Durable metal frame

**NEAH SLIM ARM** | Design by Per Weiss 2023 | Legs: Dark lacquered oak | Fabric options: Shown stock fabrics, 2-4 weeks' delivery time | Other fabric options with 6-8 weeks' delivery time, see page 163 | Scan the QR code to see additional features at our website | **Look book:** See page 32

Stock fabrics, 2-4 weeks' delivery time



357 411

80 140 160 62 195  
 70 70 70 62 44  
 99 159 179 109 205

Optional Headrest

**No-zag Spring**  
 Fabric  
 Fiberfill  
 High resilient foam  
 Fibertex  
 No-zag spring  
 Solid wood frame

**CUBED CHROME** | Design by Per Weiss 2009 | Legs: Chromed steel | Fabric options: Shown stock fabrics, 2-4 weeks' delivery time | Other fabric options with 6-8 weeks' delivery time, see page 163 | Scan the QR code to see additional features at our website | **Look book:** See page 18

Stock fabrics, 2-4 weeks' delivery time

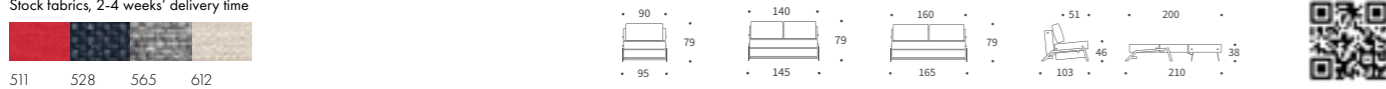

511 528 565 612

90 140 160 51 200  
 79 79 79 46 38  
 95 145 165 103 210

Bedding box Optional Headrest



**Double Spring**  
 Fabric cover  
 Fiberfill  
 High resilient foam  
 Pocket spring  
 No-zag spring  
 Durable metal frame

**NEAH STANDARD ARM** | Design by Per Weiss 2023 | Legs: Dark lacquered oak | Fabric options: Shown stock fabrics, 2-4 weeks' delivery time | Other fabric options with 6-8 weeks' delivery time, see page 163 | Scan the QR code to see additional features at our website | **Look book:** See page 26

Stock fabrics, 2-4 weeks' delivery time



357 411

80 140 160 62 195  
 70 70 70 62 44  
 127 187 207 109 205

Optional Headrest



**No-zag Spring**  
 Fabric  
 Fiberfill  
 High resilient foam  
 Fibertex  
 No-zag spring  
 Solid wood frame

**CUBED ALU** | Design by Per Weiss, Oliver & Lukas WeissKrogh 2009, 2019 | Legs: Aluminium | Fabric options: Shown stock fabrics, 2-4 weeks' delivery time | Other fabric options with 6-8 weeks' delivery time, see page 163 | Scan the QR code to see additional features at our website | **Look book:** See page 20

Stock fabrics, 2-4 weeks' delivery time



511 528 565 612

90 140 160 51 200  
 78 78 78 45 37  
 97 147 167 96 203

Bedding box Optional Headrest

**Double Spring**  
 Fabric cover  
 Fiberfill  
 High resilient foam  
 Pocket spring  
 No-zag spring  
 Durable metal frame

**NEAH X** | Design by Per Weiss 2023 | Legs: Dark lacquered oak | Fabric options: Shown stock fabric, 2-4 weeks' delivery time | Other fabric options (always with orange stitching), 6-8 weeks' delivery time, see page 163 | Scan the QR code to see additional features at our website | **Look book:** See page 24

Stock fabric, 2-4 weeks' delivery time



512

80 140 160 62 195  
 70 70 70 62 44  
 127 187 207 109 205

Optional Headrest



**No-zag Spring**  
 Fabric  
 Fiberfill  
 High resilient foam  
 Fibertex  
 No-zag spring  
 Solid wood frame

**CUBED WITH ARMS** | Design by Per Weiss 2009, 2015 | Legs: Matt black steel | Fabric options: Shown stock fabrics, 2-4 weeks' delivery time | Other fabric options with 6-8 weeks' delivery time, see page 163 | Scan the QR code to see additional features at our website | **Look book:** See page 19

Stock fabrics, 2-4 weeks' delivery time



511 528 565 612

90 140 160 51 200  
 77 77 77 44 36  
 104 154 174 103 210

Bedding box Optional Headrest



**No-zag Spring**  
 Fabric  
 Fiberfill  
 High resilient foam  
 Fibertex  
 No-zag spring  
 Solid wood frame

**OLAN** | Design by Per Weiss 2017 | Legs: Lacquered oak | Fabric options: Shown stock fabric, 2-4 weeks' delivery time | Other fabric options with 6-8 weeks' delivery time, see page 163 | Scan the QR code to see additional features at our website | **Look book:** See page 38

Stock fabric, 2-4 weeks' delivery time



565

140 55  
 81 43 69 42  
 159 91 200

Optional Headrest





**LUOMA** | Design by Per Weiss 2022 | Legs: Matt black steel | Fabric options: Shown stock fabrics, 2-4 weeks' delivery time | Other fabric options with 13-15 weeks' delivery time, see page 163 | Scan the QR code to see additional features at our website | **Look book:** See page 40

Stock fabrics, 2-4 weeks' delivery time

281 300

140 73 63 55 41 200 41

150 92

Bedding box Optional Headrest



**UNFURL LOUNGER** | Design by Andreas Lund, Flemming Højfeldt & Per Weiss 2017 | Legs: Dark lacquered oak | Fabric options: Shown stock fabrics, 2-4 weeks' delivery time | Other fabric options with 13-15 weeks' delivery time, see page 163 | Scan the QR code to see additional features at our website | **Look book:** See page 49

Stock fabrics, 2-4 weeks' delivery time

518 594

74 65 70 121 121 140 37 200

Pocket Spring  
Fabric  
Fiberfill  
High resilient foam  
Pocket spring 10 cm  
Fibertex  
Metal mesh  
Rigid metal frame



**KILLIAN** | Design by Per Weiss 2019 | Legs: Matt black steel | Fabric options: Shown stock fabrics, 2-4 weeks' delivery time | Other fabric options with 6-8 weeks' delivery time, see page 163 | Scan the QR code to see additional features at our website | **Look book:** See page 34

Stock fabrics, 2-4 weeks' delivery time

539 565

140 75 160 75 61 44 60 195 55 101 208

197 217

5-zone Multi-Pocket Spring  
Fiberfill quilted fabric  
High density foam 2 cm  
Multi-Pocket Spring 8 cm  
High density foam 2 cm  
Fiberfill quilted fabric

Dual Memory  
Fiberfill quilted fabric  
Memory foam 4 cm  
High density foam 8 cm  
Fiberfill quilted fabric



**JILLIS** | Design by Per Weiss 2024 | Legs: Glossy silver metal | Fabric options: Shown stock fabrics, 2-4 weeks' delivery time | Other fabric options with 13-15 weeks' delivery time, see page 163 | Scan the QR code to see additional features at our website | **Look book:** See page 42

Stock fabrics, 2-4 weeks' delivery time

280 511

191 60 81 76 106 40 201 92 126

Metal No-Zag Spring  
Fabric  
Fiberfill  
High resilient foam  
High resilient foam  
Fibertex  
No-zag spring  
Rigid metal frame



**EIVOR** | Design by Per Weiss 2017 | Legs: Matt black steel | Fabric options: Shown stock fabrics, 2-4 weeks' delivery time | Other fabric options with 6-8 weeks' delivery time, see page 163 | Scan the QR code to see additional features at our website | **Look book:** See page 35

Stock fabrics, 2-4 weeks' delivery time

539 565

140 75 160 75 61 44 61 195 55 101 210

174 194

5-zone Multi-Pocket Spring  
Fiberfill quilted fabric  
High density foam 2 cm  
Multi-Pocket Spring 8 cm  
High density foam 2 cm  
Fiberfill quilted fabric

Dual Memory  
Fiberfill quilted fabric  
Memory foam 4 cm  
High density foam 8 cm  
Fiberfill quilted fabric





**JILLIS WITH ARMS** | Design by Per Weiss 2024 | Legs: Glossy silver metal | Fabric options: Shown stock fabrics, 2-4 weeks' delivery time | Other fabric options with 13-15 weeks' delivery time, see page 163 | Scan the QR code to see additional features at our website | **Look book:** See page 44

Stock fabrics, 2-4 weeks' delivery time

280 511

191 60 81 76 106 40 221 92 126

Metal No-Zag Spring  
Fabric  
Fiberfill  
High resilient foam  
High resilient foam  
Fibertex  
No-zag spring  
Rigid metal frame

**UNFURL** | Design by Andreas Lund, Flemming Højfeldt & Per Weiss 2004 | Legs: Dark lacquered oak | Fabric options: Shown stock fabrics, 2-4 weeks' delivery time | Other fabric options with 13-15 weeks' delivery time, see page 163 | Scan the QR code to see additional features at our website | **Look book:** See page 40

Stock fabrics, 2-4 weeks' delivery time

217 411 536 Teddy

81 59 76 44 41 200 95 98 120

Pocket Spring  
Fabric  
Fiberfill  
High resilient foam  
Pocket spring 10 cm  
Fibertex  
Metal mesh  
Rigid metal frame



**LONG HORN D.E.L.** | Design by Per Weiss 2008 | Legs: Stainless steel | Fabric options: Shown stock fabrics, 2-4 weeks' delivery time | Other fabric options with 13-15 weeks' delivery time, see page 163 | Scan the QR code to see additional features at our website | **Look book:** See page 51

Stock fabrics, 2-4 weeks' delivery time

539 565

74 63 75 44 37 200 79 63 75 114 127 140 37 85 93 103 115 210 81 114 127 140 37

Excess Pocket Spring  
Fabric  
Fiberfill  
High resilient foam  
Pocket spring 16 cm  
Fibertex  
Metal mesh  
Rigid metal frame





**Excess Pocket Spring**  
 Fabric  
 Fiberfill  
 High resilient foam  
 Pocket spring 16 cm  
 Fibertex  
 Metal mesh  
 Rigid metal frame

**LONG HORN D.E.L. WITH ARMS** | Design by Per Weiss, Oliver & Lukas WeissKrogh 2008, 2015 | **Legs:** Stainless steel | **Arms:** Walnut veneer | **Fabric options:** Shown stock fabrics, 2-4 weeks' delivery time | Other fabric options with 13-15 weeks' delivery time, see page 163 | Scan the QR code to see additional features at our website | **Look book:** See page 50

Stock fabrics, 2-4 weeks' delivery time



539 565



**Sigmund**  
 Fabric  
 Fibertex  
 Fiberfill  
 High resilient foam  
 Pocked Spring 12 cm  
 High resilient foam  
 Fibertex

**SIGMUND DRIP** | Design by Per Weiss 2016 | **Legs:** Lacquered oak | **Fabric options:** Shown stock fabrics, 2-4 weeks' delivery time | Other fabric options with 6-8 weeks' delivery time, see page 163 | Scan the QR code to see additional features at our website | **Look book:** See page 56

Stock fabrics, 2-4 weeks' delivery time



411 579 595

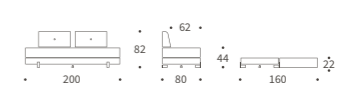

**Pocket Spring**  
 Fabric  
 Fiberfill  
 High resilient foam  
 Pocket spring 10 cm  
 Fibertex  
 Metal mesh  
 Rigid metal frame

**GHIA CRHOME** | Design by Per Weiss 2007 | **Legs:** Chromed steel | **Fabric options:** Shown stock fabrics, 2-4 weeks' delivery time | Other fabric options with 13-15 weeks' delivery time, see page 163 | Scan the QR code to see additional features at our website | **Look book:** See page 64

Stock fabrics, 2-4 weeks' delivery time



318 525 550 551 688



**Sigmund**  
 Fabric  
 Fibertex  
 Fiberfill  
 High resilient foam  
 Pocked Spring 12 cm  
 High resilient foam  
 Fibertex

**SIGMUND INDU** | Design by Per Weiss 2016 | **Legs:** Matt black steel | **Fabric options:** Shown stock fabrics, 2-4 weeks' delivery time | Other fabric options with 6-8 weeks' delivery time, see page 163 | Scan the QR code to see additional features at our website | **Look book:** See page 58

Stock fabrics, 2-4 weeks' delivery time



411 579 595

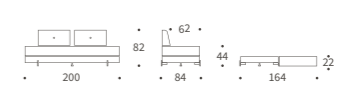

**Pocket Spring**  
 Fabric  
 Fiberfill  
 High resilient foam  
 Pocket spring 10 cm  
 Fibertex  
 Metal mesh  
 Rigid metal frame

**GHIA LASER** | Design by Per Weiss 2007, 2016 | **Legs:** Matt black steel | **Fabric options:** Shown stock fabrics, 2-4 weeks' delivery time | Other fabric options with 13-15 weeks' delivery time, see page 163 | Scan the QR code to see additional features at our website | **Look book:** See page 68

Stock fabrics, 2-4 weeks' delivery time



318 525 550 551 688



**Sigmund**  
 Fabric  
 Fibertex  
 Fiberfill  
 High resilient foam  
 Pocked Spring 12 cm  
 High resilient foam  
 Fibertex

**SIGMUND CUBE** | Design by Per Weiss 2016 | **Legs:** Aluminium | **Fabric options:** Shown stock fabrics, 2-4 weeks' delivery time | Other fabric options with 6-8 weeks' delivery time, see page 163 | Scan the QR code to see additional features at our website

Stock fabrics, 2-4 weeks' delivery time



411 579 595

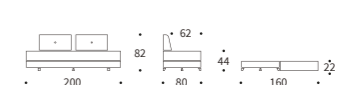

**Pocket Spring**  
 Fabric  
 Fiberfill  
 High resilient foam  
 Pocket spring 10 cm  
 Fibertex  
 Metal mesh  
 Rigid metal frame

**GHIA WOOD** | Design by Per Weiss 2007, 2015 | **Legs:** Lacquered oak | **Fabric options:** Shown stock fabrics, 2-4 weeks' delivery time | Other fabric options with 13-15 weeks' delivery time, see page 163 | Scan the QR code to see additional features at our website | **Look book:** See page 69

Stock fabrics, 2-4 weeks' delivery time



318 525 550 551 688



**Pocket Spring**  
 Fabric  
 Fiberfill  
 High resilient foam  
 Pocket spring 8 cm  
 Fibertex  
 Metal mesh  
 Rigid metal frame

**NOLIS** | Design by Oliver & Lukas WeissKrogh 2022 | **Legs:** Lacquered oak | **Fabric options:** Shown stock fabric, 2-4 weeks' delivery time | Other fabric options with 13-15 weeks' delivery time, see page 163 | Scan the QR code to see additional features at our website | **Look book:** See page 54

Stock fabric, 2-4 weeks' delivery time



539

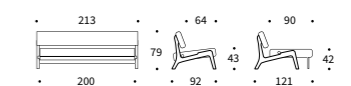



**Pocket Spring**  
 Fabric  
 Fiberfill  
 High resilient foam  
 Pocket spring 8 cm  
 Fibertex  
 Metal mesh  
 Rigid metal frame

**ZEAL STRAW** | Design by Per Weiss 2013 | **Legs:** Aluminium | **Fabric options:** Shown stock fabrics, 2-4 weeks' delivery time | Other fabric options with 13-15 weeks' delivery time, see page 163 | Scan the QR code to see additional features at our website | **Look book:** See page 63

Stock fabrics, 2-4 weeks' delivery time



316 510 539 565



**Puri**  
 Fabric  
 Fibertex  
 Fiberfill  
 High resilient foam  
 Wood frame  
 Fibertex  
 Fabric

**PURI** | Design by Per Weiss 2021 | **Legs:** Matt black metal | **Cushions:** One back cushion included, extra cushion is optional | **Fabric options:** Shown stock fabrics, 2-4 weeks' delivery time | Other fabric options with 6-8 weeks' delivery time, see page 163 | Scan the QR code to see additional features at our website | **Look book:** See page 72

Stock fabrics, 2-4 weeks' delivery time

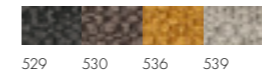

529 530 536 539

Table top color options



Oak Walnut



**Pocket Spring**  
 Fabric  
 Fiberfill  
 High resilient foam  
 Pocket spring 8 cm  
 Fibertex  
 Metal mesh  
 Rigid metal frame

**ZEAL STYLETO** | Design by Per Weiss 2013 | **Legs:** Dark lacquered oak | **Fabric options:** Shown stock fabrics, 2-4 weeks' delivery time | Other fabric options with 13-15 weeks' delivery time, see page 163 | Scan the QR code to see additional features at our website | **Look book:** See page 62

Stock fabrics, 2-4 weeks' delivery time



316 510 539 565

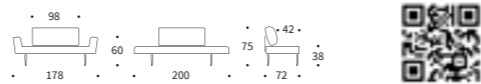

**Pocket Spring Dual**  
 Fabric  
 Fiberfill  
 High resilient foam  
 Fiberfill  
 Foam casing  
 Pocket spring 10 cm  
 Fibertex  
 Metal mesh  
 Rigid metal frame

**MALLOY** | Design by Per Weiss 2020 | **Legs:** Matt black steel | **Fabric options:** Shown stock fabrics, 2-4 weeks' delivery time | Other fabric options with 13-15 weeks' delivery time, see page 163 | Scan the QR code to see additional features at our website | **Look book:** See page 80

Stock fabrics, 2-4 weeks' delivery time

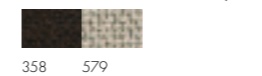

358 579

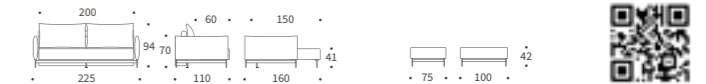

**Pocket Spring**  
 Fabric  
 Fiberfill  
 High resilient foam  
 Pocket spring 8 cm  
 Fibertex  
 Metal mesh  
 Rigid metal frame

**ZEAL BOW** | Design by Per Weiss 2013 | **Legs:** Lacquered oak | **Fabric options:** Shown stock fabrics, 2-4 weeks' delivery time | Other fabric options with 13-15 weeks' delivery time, see page 163 | Scan the QR code to see additional features at our website | **Look book:** See page 62

Stock fabrics, 2-4 weeks' delivery time



316 510 539 565



**Pocket Spring Dual**  
 Fabric  
 Fiberfill  
 High resilient foam  
 Fiberfill  
 Foam casing  
 Pocket spring 10 cm  
 Fibertex  
 Metal mesh  
 Rigid metal frame

**MALLOY WOOD** | Design by Per Weiss, Oliver & Lukas WeissKrogh 2020, 2021 | **Arms and legs:** Lacquered oak | **Fabric options:** Shown stock fabrics, 2-4 weeks' delivery time | Other fabric options with 13-15 weeks' delivery time, see page 163 | Scan the QR code to see additional features at our website | **Look book:** See page 82

Stock fabrics, 2-4 weeks' delivery time

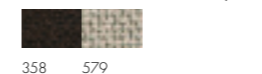

358 579

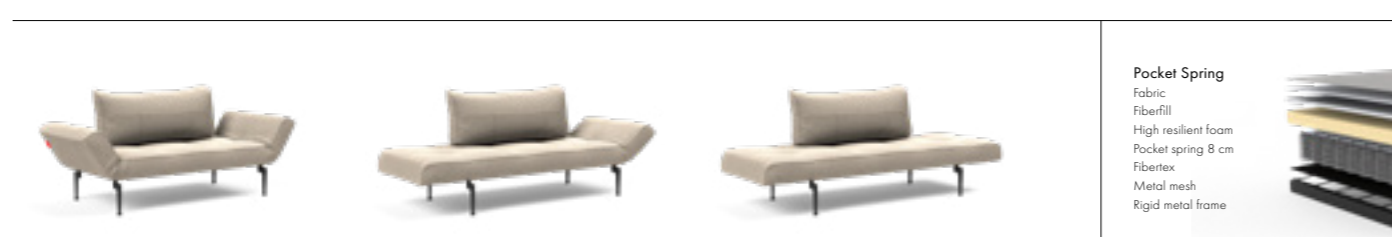

**Pocket Spring**  
 Fabric  
 Fiberfill  
 High resilient foam  
 Pocket spring 8 cm  
 Fibertex  
 Metal mesh  
 Rigid metal frame

**ZEAL LASER** | Design by Per Weiss 2013 | **Legs:** Matt black steel | **Fabric options:** Shown stock fabrics, 2-4 weeks' delivery time | Other fabric options with 13-15 weeks' delivery time, see page 163 | Scan the QR code to see additional features at our website | **Look book:** See page 62

Stock fabrics, 2-4 weeks' delivery time



316 510 539 565

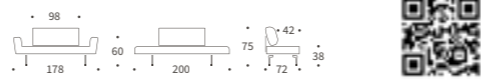

**Pocket Spring**  
 Fabric  
 Fiberfill  
 High resilient foam  
 Pocket spring 8 cm  
 Fibertex  
 Metal mesh  
 Rigid metal frame

**SIGGA X** | Design by Per Weiss 2022 | **Legs:** Matt black steel | **Fabric options:** Only available in shown fabric 300 Weda Sand | **Delivery time:** 2-4 weeks' | Scan the QR code to see additional features at our website | **Look book:** See page 98

Stock fabric, 2-4 weeks' delivery time



300





**AKELLO** | Design by Per Weiss 2024 | Fabric options: Shown stock fabrics, 2-4 weeks' delivery time | Other fabric options with 13-15 weeks' delivery time, see page 163 | Scan the QR code to see additional features at our website | **Look book:** See page 102

Stock fabrics, 2-4 weeks' delivery time



280 281

**No-zag Spring**  
 Fabric  
 Fiberfill  
 Foam  
 Fibertex  
 12cm High resilient foam  
 Fibertex  
 No-zag spring  
 Solid wood frame

Bedding box  
 Optional Headrest



**OSVALD & CORNILA** | Design by Emil Højfeldt & Per Weiss 2015, 2018 | Fabric options: Shown stock fabrics, 2-4 weeks' delivery time | Other fabric options with 6-8 weeks' delivery time, see page 163 | Scan the QR code to see additional features at our website | **Look book:** See page 86

Stock fabrics, 2-4 weeks' delivery time



282 318 412 565

**Pocket Spring Dual**  
 Fabric  
 Fiberfill  
 High resilient foam  
 Fiberfill  
 Foam casing  
 Pocket spring 10 cm  
 Fibertex  
 Metal mesh  
 Rigid metal frame

Bedding box  
 Optional Headrest



**AKELLO WITH ARMS** | Design by Per Weiss 2024 | Fabric options: Shown stock fabrics, 2-4 weeks' delivery time | Other fabric options with 13-15 weeks' delivery time, see page 163 | Scan the QR code to see additional features at our website | **Look book:** See page 104

Stock fabrics, 2-4 weeks' delivery time



280 281

**No-zag Spring**  
 Fabric  
 Fiberfill  
 Foam  
 Fibertex  
 12cm High resilient foam  
 Fibertex  
 No-zag spring  
 Solid wood frame

Bedding box  
 Optional Headrest



**CONE & CORNILA** | Design by Emil Højfeldt & Per Weiss 2015, 2018, 2023 | Fabric options: Shown stock fabrics, 2-4 weeks' delivery time | Other fabric options with 6-8 weeks' delivery time, see page 163 | Scan the QR code to see additional features at our website | **Look book:** See page 88

Stock fabrics, 2-4 weeks' delivery time



282 318 412 565

**Pocket Spring Dual**  
 Fabric  
 Fiberfill  
 High resilient foam  
 Fiberfill  
 Foam casing  
 Pocket spring 10 cm  
 Fibertex  
 Metal mesh  
 Rigid metal frame

Bedding box  
 Optional Headrest



**AKELLO LOUNGER** | Design by Per Weiss 2024 | Fabric options: Shown stock fabrics, 2-4 weeks' delivery time | Other fabric options with 13-15 weeks' delivery time, see page 163 | Scan the QR code to see additional features at our website | **Look book:** See page 105

Stock fabrics, 2-4 weeks' delivery time



280 281

**No-zag Spring**  
 Fabric  
 Fiberfill  
 Foam  
 Fibertex  
 12cm High resilient foam  
 Fibertex  
 No-zag spring  
 Solid wood frame

Bedding box  
 Optional Headrest



**PYXIS D.E.L.** | Design by Per Weiss 2008, 2021 | Legs: Lacquered oak | Fabric options: Shown stock fabrics, 2-4 weeks' delivery time | Other fabric options with 13-15 weeks' delivery time, see page 163 | Scan the QR code to see additional features at our website | **Look book:** See page 112

Stock fabrics, 2-4 weeks' delivery time



528 563 587

**Excess Pocket Spring**  
 Fabric  
 Fiberfill  
 High resilient foam  
 Pocket spring 16 cm  
 Fibertex  
 Metal mesh  
 Rigid metal frame

Optional Headrest



**AKELLO LOUNGER WITH ARMS** | Design by Per Weiss 2024 | Fabric options: Shown stock fabrics, 2-4 weeks' delivery time | Other fabric options with 13-15 weeks' delivery time, see page 163 | Scan the QR code to see additional features at our website | **Look book:** See page 106

Stock fabrics, 2-4 weeks' delivery time



280 281

**No-zag Spring**  
 Fabric  
 Fiberfill  
 Foam  
 Fibertex  
 12cm High resilient foam  
 Fibertex  
 No-zag spring  
 Solid wood frame

Bedding box  
 Optional Headrest



**BIFROST D.E.L.** | Design by Per Weiss 2008 | Arms and legs: Black stained wood | Fabric options: Shown stock fabrics, 2-4 weeks' delivery time | Other fabric options with 13-15 weeks' delivery time, see page 163 | Scan the QR code to see additional features at our website | **Look book:** See page 116

Stock fabrics, 2-4 weeks' delivery time



528 563 587

**Excess Pocket Spring**  
 Fabric  
 Fiberfill  
 High resilient foam  
 Pocket spring 16 cm  
 Fibertex  
 Metal mesh  
 Rigid metal frame

Optional Headrest





**Excess Pocket Spring**  
 Fabric  
 Fiberfill  
 High resilient foam  
 Pocket spring 16 cm  
 Fibertex  
 Metal mesh  
 Rigid metal frame

**SUPREMAX D.E.L.** | Design by Per Weiss 2008 | Legs: Chromed steel | Fabric options: Shown stock fabrics, 2-4 weeks' delivery time | Other fabric options with 13-15 weeks' delivery time, see page 163 | Scan the QR code to see additional features at our website | **Look book:** See page 114

Stock fabrics, 2-4 weeks' delivery time



528 563 587

200 83 62 117 155 40 65 65

Optional Headrest



**Pocket Spring**  
 Fabric  
 Fiberfill  
 High resilient foam  
 Pocket spring 12 cm  
 Fibertex  
 Metal mesh  
 Rigid metal frame

**SLY** | Design by Per Weiss 2006 | Legs: Matt black steel | Fabric options: Shown stock fabrics, 2-4 weeks' delivery time | Other fabric options with 13-15 weeks' delivery time, see page 163 | Scan the QR code to see additional features at our website | **Look book:** See page 96

Stock fabrics, 2-4 weeks' delivery time



359 527 528 563

200 84 50 94 140 41

Bedding box

Optional Headrest



**Excess Pocket Spring**  
 Fabric  
 Fiberfill  
 High resilient foam  
 Pocket spring 16 cm  
 Fibertex  
 Metal mesh  
 Rigid metal frame

**CASSIUS D.E.L.** | Design by Per Weiss 2008 | Legs: Chromed steel | Fabric options: Shown stock fabrics, 2-4 weeks' delivery time | Other fabric options with 13-15 weeks' delivery time, see page 163 | Scan the QR code to see additional features at our website | **Look book:** See page 115

Stock fabrics, 2-4 weeks' delivery time



528 563 587

200 62 155 83 66 117 167 40 65 65

Optional Headrest



**Pocket Spring**  
 Fabric  
 Fiberfill  
 High resilient foam  
 Pocket spring 12 cm  
 Fibertex  
 Metal mesh  
 Rigid metal frame

**SLY WOOD** | Design by Per Weiss 2006, 2021 | Legs: Lacquered oak | Fabric options: Shown stock fabrics, 2-4 weeks' delivery time | Other fabric options with 13-15 weeks' delivery time, see page 163 | Scan the QR code to see additional features at our website | **Look book:** See page 97

Stock fabrics, 2-4 weeks' delivery time



359 527 528 563

200 84 50 94 140 42

Bedding box

Optional Headrest



**Pocket Spring**  
 Fabric  
 Fiberfill  
 High resilient foam  
 Pocket spring 10 cm  
 Fibertex  
 Metal mesh  
 Rigid metal frame

**RECAST** | Design by Per Weiss 2011, 2015 | Legs: Dark lacquered oak | Fabric options: Shown stock fabrics, 2-4 weeks' delivery time | Other fabric options with 13-15 weeks' delivery time, see page 163 | Scan the QR code to see additional features at our website | **Look book:** See page 95

Stock fabrics, 2-4 weeks' delivery time



357 536

200 76 55 98 140 40 66 40

Bedding box

Optional Headrest



**Pocket Spring**  
 Fabric  
 Fiberfill  
 High resilient foam  
 Pocket spring 10 cm  
 Fibertex  
 Metal mesh  
 Rigid metal frame

**IDUN** | Design by Per Weiss 2014 | Legs: Lacquered oak | Fabric options: Shown stock fabrics, 2-4 weeks' delivery time | Other fabric options with 13-15 weeks' delivery time, see page 163 | Scan the QR code to see additional features at our website | **Look book:** See page 108

Stock fabrics, 2-4 weeks' delivery time



521 539

200 80 50 56 140 39 242 100

Bedding box

Optional Headrest

Detachable & washable covers



**Pocket Spring**  
 Fabric  
 Fiberfill  
 High resilient foam  
 Pocket spring 10 cm  
 Fibertex  
 Metal mesh  
 Rigid metal frame

**RECAST WITH ARMS** | Design by Per Weiss 2011, 2015 | Legs: Dark lacquered oak | Arms: Walnut veneer | Fabric options: Shown stock fabrics, 2-4 weeks' delivery time | Other fabric options with 13-15 weeks' delivery time, see page 163 | Scan the QR code to see additional features at our website | **Look book:** See page 94

Stock fabrics, 2-4 weeks' delivery time



357 536

200 76 55 57 98 140 40 66 40

224 98 140 39

Bedding box

Optional Headrest



**Pocket Spring**  
 Fabric  
 Fiberfill  
 High resilient foam  
 Pocket spring 10 cm  
 Fibertex  
 Metal mesh  
 Rigid metal frame

**TRYM** | Design by Per Weiss 2014 | Legs: Lacquered oak | Fabric options: Shown stock fabrics, 2-4 weeks' delivery time | Other fabric options with 13-15 weeks' delivery time, see page 163 | Scan the QR code to see additional features at our website | **Look book:** See page 109

Stock fabrics, 2-4 weeks' delivery time



521 539

200 80 50 56 140 39 242 100

Bedding box

Optional Headrest

Detachable & washable covers





**ELIS** | Design by Per Weiss 2023 | Legs: Dark lacquered oak | Fabric options: Only available in the shown fabric: 2-4 weeks' delivery time | Scan the QR code to see additional features at our website | Look book: See page 92

Stock fabric, 2-4 weeks' delivery time

280

**Pocket Spring**  
Fabric  
Fiberfill  
High resilient foam  
Pocket spring 10 cm  
Fibertex  
Metal mesh  
Rigid metal frame

Bedding box  
Optional Headrest  
Detachable & washable covers





**YONATA** | Design by Emil Højfeldt & Per Weiss 2021 | Legs: Matt black aluminum | Fabric options: Shown stock fabric, 2-4 weeks' delivery time | Other fabric options with 13-15 weeks' delivery time, see page 163 | Scan the QR code to see additional features at our website | Look book: See page 90

Stock fabric, 2-4 weeks' delivery time

586

**Excess Pocket Spring**  
Fabric  
Fiberfill  
High resilient foam  
Pocket spring 16 cm  
Fibertex  
Metal mesh  
Rigid metal frame

Detachable & washable covers





**NEWILLA** | Design by Per Weiss 2022 | Fabric options: Shown stock fabrics, 2-4 weeks' delivery time | Other fabric options with 6-8 weeks' delivery time, see page 163 | Scan the QR code to see additional features at our website | Look book: See page 78

Stock fabrics, 2-4 weeks' delivery time

357 530 594

**No-zag and Pocket Spring**  
Fabric  
Fibertex  
Fiberfill  
Hyper soft foam  
High resilient foam  
Pocket Spring  
Fibertex  
No-zag spring  
Solid wood frame

Bedding box  
Optional Headrest  
Detachable & washable covers





**NEWILLA WITH LOUNGER** | Design by Per Weiss 2022 | Lounger: Left/right reversible | Fabric options: Shown stock fabrics, 2-4 weeks' delivery time | Other fabric options with 6-8 weeks' delivery time, see page 163 | Scan the QR code to see additional features at our website | Look book: See page 74

Stock fabrics, 2-4 weeks' delivery time

357 530 594

**No-zag and Pocket Spring**  
Fabric  
Fibertex  
Fiberfill  
Hyper soft foam  
High resilient foam  
Pocket Spring  
Fibertex  
No-zag spring  
Solid wood frame

Bedding box  
Optional Headrest  
Detachable & washable covers





**LOMIRA** | Design by Per Weiss 2024 | Frame: Metal frame with beech wood slats | Design it yourself guide: See page 118 | Legs: Chromed steel | Frame covers: Back frame cover included, optional seat frame cover | Fabric options: 2-4 weeks' delivery time | Scan the QR code to see additional features at our website | Look book: See page 126

Available in all fabrics  
2-4 weeks' delivery time  
See page 163

Select mattress type  
Classic  
Spring  
Soft Spring  
Latex

Select cover style  
Fixed covers:  
Nordic mattress  
Sharp plus cover

Detachable covers:  
Nordic cover  
Sharp plus cover

5 step head-elevation  
Bedding box  
Detachable & washable covers





**JUNUS** | Design by Per Weiss 2021 | Frame: Metal frame with beech wood slats | Design it yourself guide: See page 118 | Legs: Matt black steel | Frame covers: Back frame cover included, optional seat frame cover | Fabric options: 2-4 weeks' delivery time | Scan the QR code to see additional features at our website | Look book: See page 128

Available in all fabrics  
2-4 weeks' delivery time  
See page 163

Select mattress type  
Classic  
Spring  
Soft Spring  
Latex

Select cover style  
Fixed covers:  
Nordic mattress  
Sharp plus cover

Detachable covers:  
Nordic cover  
Sharp plus cover

5 step head-elevation  
Bedding box  
Detachable & washable covers





**ASLAK** | Design by Per Weiss, Oliver & Lukas WeissKrogh 2014 | Frame: Metal frame with beech wood slats | Design it yourself guide: See page 118 | Legs: Lacquered oak | Frame covers: Back frame cover included, optional seat frame cover | Fabric options: 2-4 weeks' delivery time | Scan the QR code to see additional features at our website | Look book: See page 122

Available in all fabrics  
2-4 weeks' delivery time  
See page 163

Select mattress type  
Classic  
Spring  
Soft Spring  
Latex

Select cover style  
Fixed covers:  
Nordic mattress  
Sharp plus cover

Detachable covers:  
Nordic cover  
Sharp plus cover

5 step head-elevation  
Bedding box  
Detachable & washable covers





**BALDER** | Design by Per Weiss, Oliver & Lukas WeissKrogh 2015 | Frame: Metal frame with beech wood slats | Design it yourself guide: See page 118 | Arms: Lacquered oak | Frame covers: Back frame cover included, optional seat frame cover | Fabric options: 2-4 weeks' delivery time | Scan the QR code to see additional features at our website | Look book: See page 124

Available in all fabrics  
2-4 weeks' delivery time  
See page 163

Select mattress type  
Classic  
Spring  
Soft Spring  
Latex

Select cover style  
Fixed covers:  
Nordic mattress  
Sharp plus cover

Detachable covers:  
Nordic cover  
Sharp plus cover

5 step head-elevation  
Bedding box  
Detachable & washable covers







Select mattress type		Select cover style		Detachable covers:
				
				

**COLPUS** | Design by Per Weiss 2014 | **Frame:** Metal frame with beech wood slats | **Design it yourself guide:** See page 118 | **Frame covers:** Back frame cover included, optional seat frame cover | **Fabric options:** 2-4 weeks' delivery time | Scan the QR code to see additional features at our website | **Look book:** See page 131

Available in all fabrics  
2-4 weeks' delivery time  
See page 163













Select mattress type		Select cover style		Detachable covers:
				
				

**ROLLO STEM** | Design by Flemming Højfeldt & Per Weiss 1993 | **Frame:** Metal frame with beech wood slats | **Optional:** Detachable mattress cover, frame cover and cushions | **Legs:** Lacquered oak | **Fabric options:** 2-4 weeks' delivery time | Scan the QR code to see additional features at our website

Available in all fabrics  
2-4 weeks' delivery time  
See page 163

Select mattress type		Select cover style		Detachable covers:
				
				

**MINIMUM** | Design by Peter Henriksen & Per Weiss 2003 | **Frame:** Metal frame with beech wood slats | **Design it yourself guide:** See page 118 | **Legs:** Chromed steel | **Frame covers:** Back frame cover included, optional seat frame cover | **Fabric options:** 2-4 weeks' delivery time | Scan the QR code to see additional features at our website | **Look book:** See page 120

Available in all fabrics  
2-4 weeks' delivery time  
See page 163

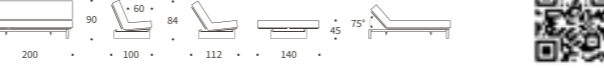

Select mattress type		Select cover style		Detachable covers:
				
				

**ROLLO STYLETTO** | Design by Flemming Højfeldt & Per Weiss 1993 | **Frame:** Metal frame with beech wood slats | **Optional:** Detachable mattress cover, frame cover and cushions | **Legs:** Dark lacquered oak | **Fabric options:** 2-4 weeks' delivery time | Scan the QR code to see additional features at our website | **Look book:** See page 60

Available in all fabrics  
2-4 weeks' delivery time  
See page 163



Select mattress type		Select cover style		Detachable covers:
				
				



**FRACTION** | Design by Per Weiss 2008 | **Frame:** Metal frame with beech wood slats | **Design it yourself guide:** See page 118 | **Legs:** Matt black steel | **Frame covers:** Back frame cover included, optional seat frame cover | **Fabric options:** 2-4 weeks' delivery time | Scan the QR code to see additional features at our website | **Look book:** See page 130







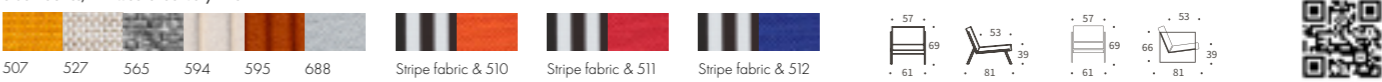

Available in all fabrics  
2-4 weeks' delivery time  
See page 163

**VIKKO CHAIR & VIKKO CHAIR WITH ARMS** | Design by Emil Højfeldt & Per Weiss 2018, 2020 | **Legs:** Matt black steel | **Fabric options:** Shown stock fabrics, 2-4 weeks' delivery time | Other fabric options with 6-8 weeks' delivery time, see page 163 | Scan the QR code to see additional features at our website | **Look book:** See pages 132, 133 & 138

Stock fabrics, 2-4 weeks' delivery time

Select mattress type		Select cover style		Detachable covers:
				
				

**ROLLO BOW** | Design by Flemming Højfeldt & Per Weiss 1993 | **Frame:** Metal frame with beech wood slats | **Optional:** Detachable mattress cover, frame cover and cushions | **Legs:** Lacquered oak | **Fabric options:** 2-4 weeks' delivery time | Scan the QR code to see additional features at our website

Available in all fabrics  
2-4 weeks' delivery time  
See page 163



## FABRIC SPECIFICATIONS

We place high value on ensuring that our fabrics all match the high quality of the design as well as durability of our sofa beds. All fabrics are enhanced with additional backing for extended life time and undergo rigid testing to meet the high standards we impose on our designs and production. To ensure our fabrics are free of harmful substances, all our fabrics are OEKO-TEX® certified.

For detailed fabric information please scan the QR code.



Name	Composition	Color fastness to light (scale 1-5)	Pilling resistance (scale 1-5)	Martindale	OEKO-TEX®	Machine washable	Water repellent
Avella	100% Polyester	4-5	4-5	85.000	•	•	
Bouclé	55% Recycled polyester / 45% Polyester	4-5	4	27.000	•	•	
Blida	80 % Polyester / 20 % Linen	4-5	3-4	200.000	•	•	
Cordufine	85 % Polyester / 15 % Polyamide	4-5	4-5	100.000	•	•	•
Corduroy	100% Polyester	4-5	4	109.000	•	•	
Elegance	100 % Polyester	4-5	4	60.000	•	•	•
Esina	45% Recycled polyester / 55 % Polyester	5	4-5	100.000	•	•	
Faunal	80 % Polyester / 17,5% Leather / 2,5 % Polyurethane	4-5	4	56.000	•		
Flashtex	100 % Polyester	4-5	4-5	116.000	•	•	•
Kenya	100 % Polyester	4-5	3-4	119.000	•	•	
Mixed Dance	100 % Polyester	4-5	4-5	85.500	•	•	
Phobos	100 % Polyester	4-5	4	100.000	•	•	
Silvershine	100 % Polyurethan	4	3-4	50.000	•		
Taura	96 % Polyester / 4 % Acrylic	5	4-5	45.000	•	•	
Twist	100 % Polyester	4-5	4	36.000	•	•	
Weda	100 % Polyester	4-5	4	100.000	•	•	

### Cleaning advisory

Fabrics: Machine washable at 30 degrees Celcius if the cover can be removed.  
 Leather looks: Wipe with a moist cloth, do not dry clean.

Please visit [innovationliving.com](http://innovationliving.com) for further information or scan the QR code below.



## FABRIC COLLECTION

Please note that the printed presentation of the fabric texture and colors may vary from the actual fabric.

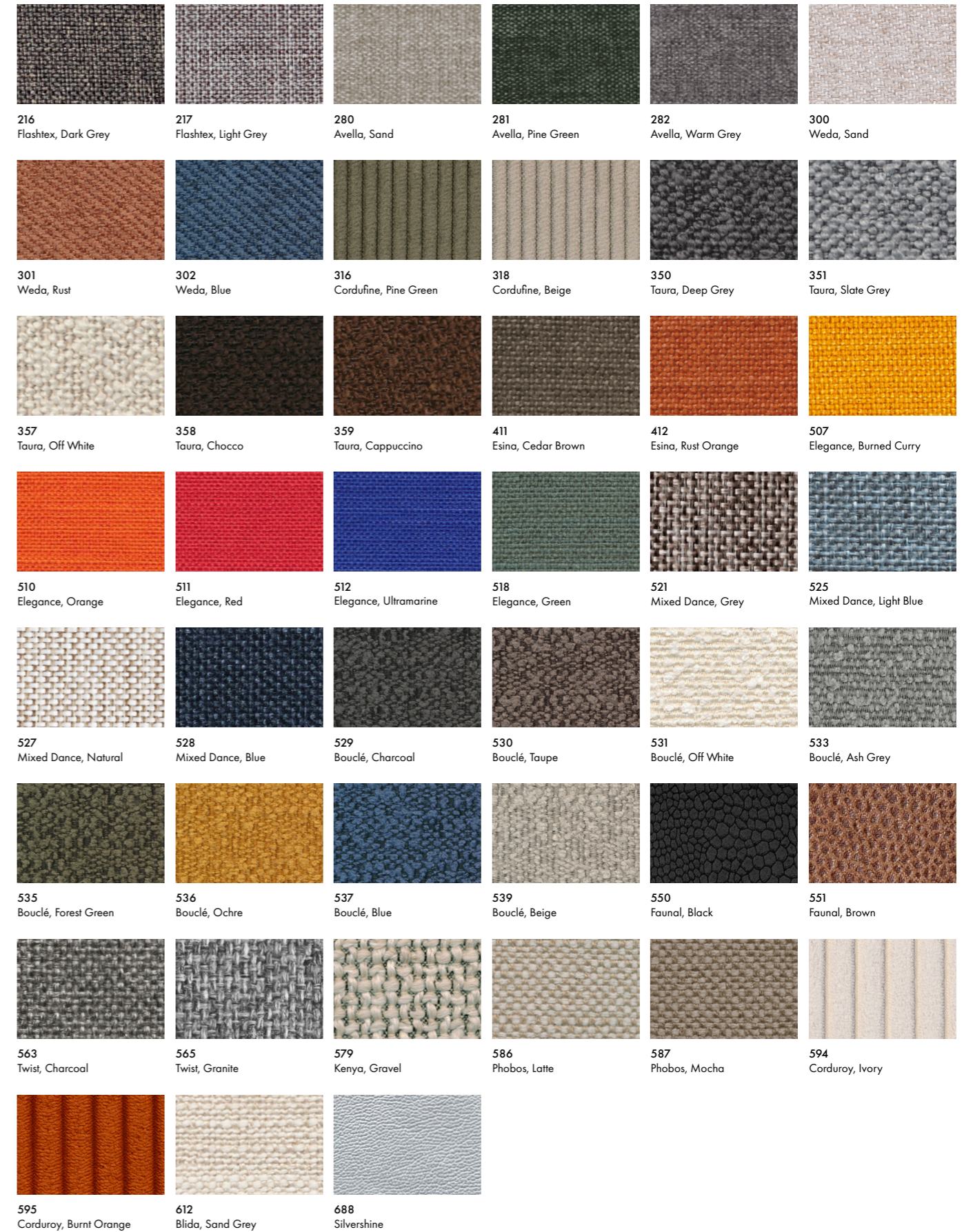

# THE DANISH SOFA BED SPECIALIST ESTABLISHED IN 1971



@innovationliving



@innovationliving



@innovationtm



@innovation-living

